

Project Name:	Notes:	Date:	Type:
---------------	--------	-------	-------

DESCRIPTION

Portor's AL1 area light series features makes outdoor lighting dazzling and luminaire maintenance a breeze, while also reducing energy consumption.

Ideal use for parking lots, roadways, car dealership, walkways, school/campuses, shopping centers and industrial areas.



CONSTRUCTION

Die-cast aluminum body, state-of-the-art heat dissipation, shorting cap standard and tool-less access to driver housing. Waterproof, built rugged for outdoor weather.

ELECTRICAL

Luminaire is built with the highest quality 100-277VAC universal drivers and a water resistant LED chips (custom order available for 347-480VAC driver).

OPTICAL SYSTEM

Type III optics designed to reduce glare and improved light distribution through precision formed lens optics.

DIMMING

0-10V dimmable standard. Photocell ready, motion sensor/daylight harvesting ready.

DIMMING

Multiple mounting options available: slipfitter, square-pole mount, round-pole mount, wall mount and trunnion mount.

LISTING

ETL Listed for wet location, FCC, RoHS, CE, IP65 Rated
DLC Listed

TECHNICAL SPECIFICATION

WATTAGE	100W
LUMENS	13,700 lumens
EFFICACY	135 lm/W
VOLTAGE	AC100-277V (347-480V custom order)
POWER FREQUENCY	50/60 Hz
CCT	5000K (other CCT custom order)
CRI	Ra>80
DISTRIBUTION	Type 3
WORKING TEMP.	-40°F - +122°F
IP RATING	IP65 Wet Location
DIMMABLE	0-10V dimming
SENSOR	Photocell/Motion Sensor ready
POWER FACTOR	>0.93
THD	≤10%
WARRANTY	5 year limited



MODEL NUMBER(S)

MODEL#	WATTS	LUMENS	LM/WATT	CCT	CRI	DISTRIBUTION	VOLTAGE
PT-AL1-100W-5K-W	100W	13,700	135	5000K	>80	Type 3	AC 100/277V
PT-AL1-150W-5K-W	150W	20,550	135	5000K	>80	Type 3	AC 100/277V
PT-AL1-200W-5K-W	200W	27,400	135	5000K	>80	Type 3	AC 100/277V
PT-AL1-240W-5K-W	240W	32,880	135	5000K	>80	Type 3	AC 100/277V
PT-AL1-300W-5K-W	300W	41,000	140	5000K	>80	Type 3	AC 100/277V

Project Name:	Notes:	Date:	Type:
---------------	--------	-------	-------

DIMENSION

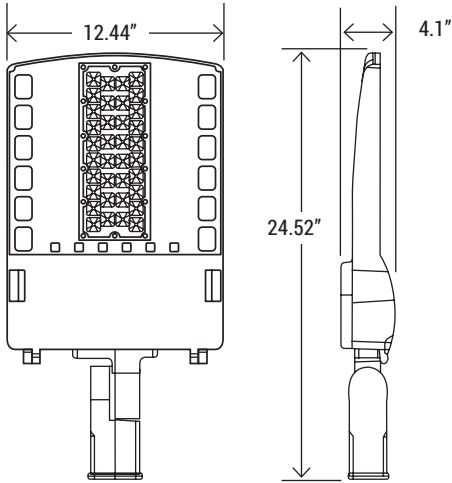

AVAILABLE OPTION SENSOR



PT-A-MSA-D
Microwave motion sensor



PT-ALG-A-PC
Photocell



PT-A-SP
Surge Protector

MOUNTING OPTIONS



PT-AL1-A-SF-W
White Slipfitter



PT-AL1-A-RPM-W
White Round Pole Mount



PT-AL1-A-SPM-W
White Square Mount



PT-AL1-A-TM-W
White Trunnion Mount

PHOTOMETRY

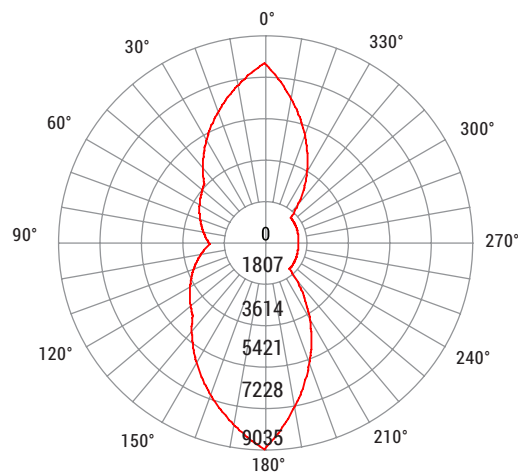
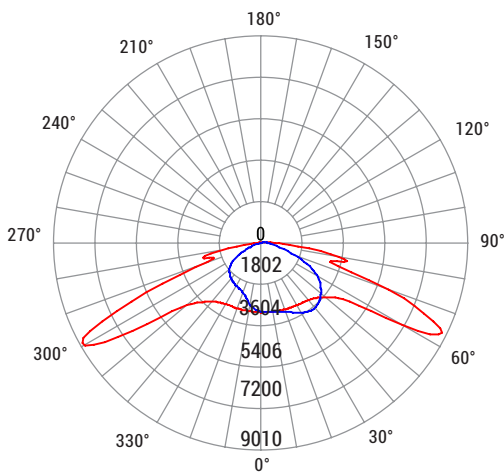

UNIT: cd
— C0, 137.6
— C90, 119.4

Average Beam Angle (50%)