

Project Name:	Notes:	Date:	Type:
---------------	--------	-------	-------

DESCRIPTION

Portor's AL1 area light series features makes outdoor lighting dazzling and luminaire maintenance a breeze, while also reducing energy consumption.

Ideal use for parking lots, roadways, car dealerships, walkways, schools/campuses, shopping centers and industrial areas.



CONSTRUCTION

Die-cast aluminum body, state-of-the-art heat dissipation, shorting cap standard and tool-less access to driver housing. Waterproof, built rugged for outdoor weather.

ELECTRICAL

Luminaire is built with the highest quality 100-277VAC universal drivers and water resistant LED chips (custom order available for 347-480VAC driver).

OPTICAL SYSTEM

Type III optics designed to reduce glare and improve light distribution through precision formed lens optics.

DIMMING

0-10V dimmable standard. Photocell ready, motion sensor/daylight harvesting ready.

DIMMING

Multiple mounting options available: slipfitter, square-pole mount, round-pole mount, wall mount and trunnion mount.

LISTING

ETL Listed for wet location, FCC, RoHS, CE, IP65 Rated
DLC Listed

TECHNICAL SPECIFICATION

WATTAGE	240W
LUMENS	35,569 lumens
EFFICACY	148 lm/W
VOLTAGE	AC100-277V (347-480V custom order)
POWER FREQUENCY	50/60 Hz
CCT	5000K (other CCT custom order)
CRI	80+
DISTRIBUTION	Type 3
WORKING TEMP.	-40°F - +122°F
IP RATING	IP65 Wet Location
DIMMABLE	0-10V dimming
SENSOR	Photocell/Motion Sensor ready
POWER FACTOR	>0.93
THD	≤10%
WARRANTY	5 year limited



MODEL NUMBER(S)							
MODEL#	WATTS	LUMENS	LM/WATT	CCT	CRI	DISTRIBUTION	VOLTAGE
PT-AL1-100W-5K-W	100W	15,526	155	5000K	80+	Type 3	AC 100/277V
PT-AL1-150W-5K-W	150W	24,515	156	5000K	80+	Type 3	AC 100/277V
PT-AL1-200W-5K-W	200W	31,218	160	5000K	80+	Type 3	AC 100/277V
PT-AL1-240W-5K-W *	240W	35,569	148	5000K	80+	Type 3	AC 100/277V
PT-AL1-300W-5K-W	300W	45,313	154	5000K	80+	Type 3	AC 100/277V

*CUSTOM ORDER

Project Name:	Notes:	Date:	Type:
---------------	--------	-------	-------

DIMENSION

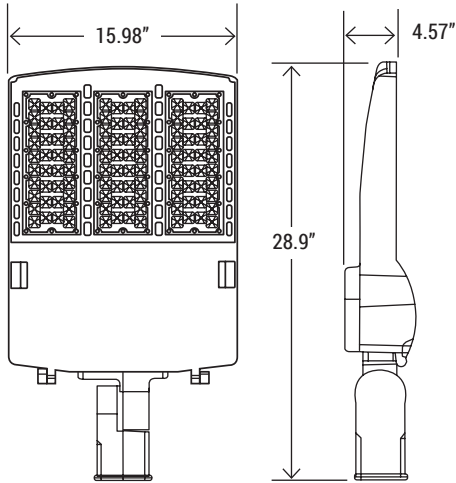

AVAILABLE OPTION SENSOR



PT-A-MSA-D
Microwave motion sensor



PT-ALG-A-PC
Photocell



PT-A-SP
Surge Protector

MOUNTING OPTIONS



PT-AL1-A-SF-W
White Slipfitter



PT-AL1-A-SPM-W
White Adjustable Mount For Square Pole

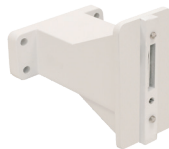

PT-AL1-A-SAM-W
White Straight Arm Mount for Square Pole



PT-AL1-A-TM-W
White Trunnion Mount



PT-AL1-A-RPMA-W
White Round Pole Mount Adapter

PHOTOMETRY

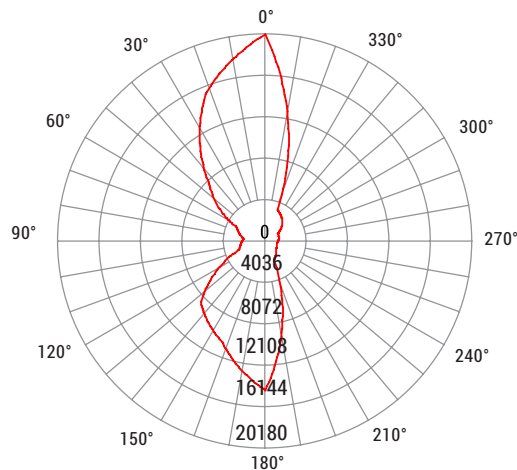
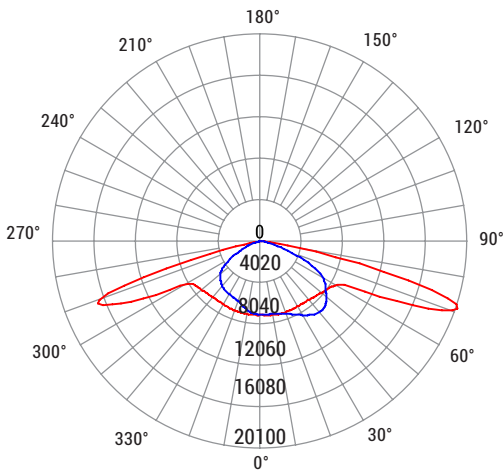

UNIT: cd
— C0, 149.7
— C90, 121.1

Average Beam Angle (50%)