

Project Name:	Notes:	Date:	Type:
---------------	--------	-------	-------

**DESCRIPTION**

Portor's AL1 area light series features makes outdoor lighting dazzling and luminaire maintenance a breeze, while also reducing energy consumption.

Ideal use for parking lots, roadways, car dealerships, walkways, schools/campuses, shopping centers and industrial areas.



**CONSTRUCTION**

Die-cast aluminum body, state-of-the-art heat dissipation, shorting cap standard and tool-less access to driver housing. Waterproof, built rugged for outdoor weather.

**ELECTRICAL**

Luminaire is built with the highest quality 100-277VAC universal drivers and water resistant LED chips (custom order available for 347-480VAC driver).

**OPTICAL SYSTEM**

Type III optics designed to reduce glare and improve light distribution through precision formed lens optics.

**DIMMING**

1-10V dimmable standard. Photocell ready, motion sensor/daylight harvesting ready.

**DIMMING**

Multiple mounting options available: slipfitter, square-pole mount, round-pole mount, wall mount and trunnion mount.

**LISTING**

ETL Listed for wet location, FCC, RoHS, CE, IP65 Rated  
DLC Listed

**TECHNICAL SPECIFICATION**

WATTAGE	300W
LUMENS	45,313 lumens
EFFICACY	154 lm/W
VOLTAGE	AC100-277V (347-480V custom order)
POWER FREQUENCY	50/60 Hz
CCT	5000K (other CCT custom order)
CRI	80+
DISTRIBUTION	Type 3
WORKING TEMP.	-40°F - +122°F
IP RATING	IP65 Wet Location
DIMMABLE	1-10V dimming
SENSOR	Photocell/Motion Sensor ready
POWER FACTOR	>0.93
THD	≤10%
WARRANTY	5 year limited



**MODEL NUMBER(S)**

MODEL#	WATTS	LUMENS	LM/WATT	CCT	CRI	DISTRIBUTION	VOLTAGE
PT-AL1-100W-5K	100W	15,526	155	5000K	80+	Type 3	AC 100/277V
PT-AL1-150W-5K	150W	24,515	156	5000K	80+	Type 3	AC 100/277V
PT-AL1-200W-5K	200W	31,218	160	5000K	80+	Type 3	AC 100/277V
PT-AL1-240W-5K	240W	35,569	148	5000K	80+	Type 3	AC 100/277V
PT-AL1-300W-5K	300W	45,313	154	5000K	80+	Type 3	AC 100/277V

Project Name:	Notes:	Date:	Type:
---------------	--------	-------	-------

**DIMENSION**

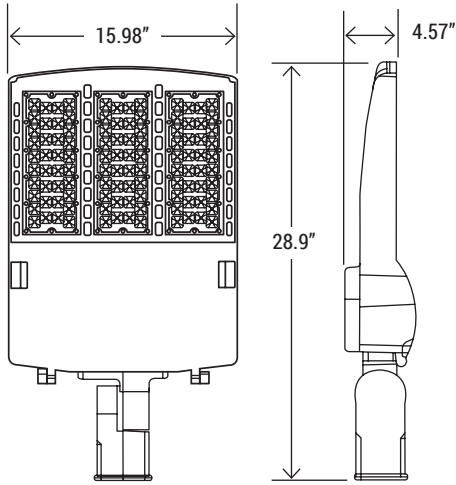

**AVAILABLE OPTION SENSOR**



**PT-A-MSA-D**  
Microwave motion sensor



**PT-ALG-A-PC**  
Photocell



**PT-A-SP**  
Surge Protector

**MOUNTING OPTIONS**



**PT-AL1-A-SF**  
Slipfitter



**PT-AL1-A-SPM**  
Adjustable Mount For Square Pole



**PT-AL1-A-SAM**  
Straight Arm Mount for Square Pole



**PT-AL1-A-TM**  
Trunnion Mount



**PT-AL1-A-RPMA**  
Round Pole Mount Adapter

**PHOTOMETRY**

