

Project Name:	Notes:	Date:	Type:
---------------	--------	-------	-------

DESCRIPTION

Excellent optical design, greatly improves the light utilization and evenness. The LED driver is mounted in direct contact with the casting to promote low operating temperature and long life.

Ideal use for parking lots, roadways, car dealership, walkways, school/campuses, shopping centers and industrial areas.



CONSTRUCTION

Cast aluminum housing design with superior cooling system and easy access to driver housing.

ELECTRICAL

Luminaire is built with the highest quality 100-277VAC universal drivers and a water resistant LED chips (custom order available for 347-480VAC driver).

OPTICAL SYSTEM

Designed to reduce glare and improved light distribution through precision formed lens optics. Type III optics standard (custom order available for Type V optics).

DIMMING

1-10V dimmable standard

CERTIFICATION

UL Listed, FCC, RoHS, CE, IP65 Rated

TECHNICAL SPECIFICATION

WATTAGE	100W
LUMENS	12,200 lumens
EFFICACY	122 lm/W
VOLTAGE	AC120-277V (347-480V custom order)
POWER FREQUENCY	50/60 Hz
CCT	5000K (other CCT custom order)
CRI	Ra>70
DISTRIBUTION	Type 3
WORKING TEMP.	-40°F - +122°F
STORAGE TEMP.	-40°F - +158°F
IP RATING	IP65 Wet Location
DIMMABLE	1-10V dimming
POWER FACTOR	>0.95
THD	≤20%
WARRANTY	5 year limited
PORTOR CAT#	PT-ALT-100W-5K



MODEL NUMBER(S)

MODEL#	WATTS	LUMENS	LM/WATT	CCT	CRI	DISTRIBUTION	VOLTAGE
TS-B-BOX10-100W-H3	100W	12,200	122	5000K	>80	Type 3	AC 100/277V
TS-B-BOX10-150W-H4	150W	16,160	130	5000K	>80	Type 3	AC 100/277V
TS-B-BOX10-200W-H3	200W	24,200	122	5000K	>80	Type 3	AC 100/277V
TS-B-BOX10-300W-H3	300W	38,280	125	5000K	>80	Type 3	AC 100/277V

Project Name:	Notes:	Date:	Type:
---------------	--------	-------	-------

DIMENSION

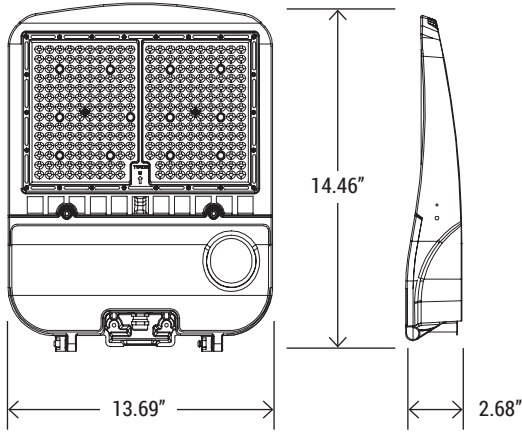

MOUNTING ACCESSORIES



PT-ALT-A-SF
Slipfitter



PT-ALT-A-SQM
Square Mount



PT-ALT-A-TM
Trunnion Mount

PHOTOMETRY

