

Project Name:	Notes:	Date:	Type:
---------------	--------	-------	-------

DESCRIPTION

Tired of the standard-looking flood light? The small but nimble FLM1 flood light series is for you! Available with knuckle mount or a yoke mount.

Ideal use for facades, outdoor signage, buildings, shopping centers, industrial areas and other outdoor places where spot lighting is needed.



Knuckle Mount



Yoke Mount

CONSTRUCTION

Die-cast aluminum housing. Sealed by a silicone ring that makes the fixture waterproof.

ELECTRICAL

Luminaire is built with the highest quality 120-277VAC universal drivers.

OPTICAL SYSTEM

Robust glass lens designed to reduce glare and improve light distribution through precision formed lens optics.

LISTING

UL Listed for Wet Location, FCC, RoHS, IP65 Rated
DLC Listed

TECHNICAL SPECIFICATION

WATTAGE	30W
LUMENS	3,982 lumens (@ 3000K) 3,600 lumens (@ 5000K)
EFFICACY	129 lm/W (@ 3000K) 120 lm/W (@ 5000K)
VOLTAGE	AC120-277V
POWER FREQUENCY	50/60 Hz
CCT	3000K, 5000K
CRI	70
DISTRIBUTION ANGLE	80°x110°
WORKING TEMP.	-40°F - +113°F
STORAGE TEMP.	-40°F - +158°F
IP RATING	IP65 Wet Location
DIMMABLE	Non-dimming
POWER FACTOR	>0.9
LIFE SPAN	50,000 hrs
WARRANTY	5 year limited



ORDERING SAMPLE: PT-FLM1-30W - 80X110 - K - 50K - PT-FLM1-A-JB

Series	Distribution	Mounting	CCT	Options
PT-FLM1-30W 30W LED Mini Flood Series	80X110 (80° x 110°)	<input type="checkbox"/> K (Knuckle) <input type="checkbox"/> Y (Yoke)	<input type="checkbox"/> 30K (3000K) <input type="checkbox"/> 50K (5000K)	<input type="checkbox"/> PT-FLM1-A-JB

Project Name:	Notes:	Date:	Type:
---------------	--------	-------	-------

FEATURES

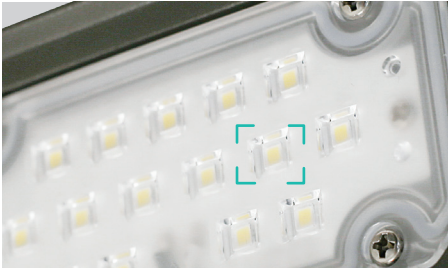

DISTRIBUTION LENS
1:1 lens to LED diode ratio, maximizing light distribution

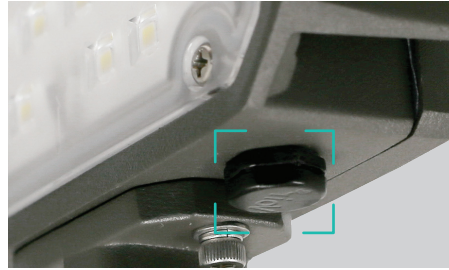

CONDENSATION VALVE
The FLM1 uses a state-of-the-art condensation valve, preventing water from collecting behind the lens.

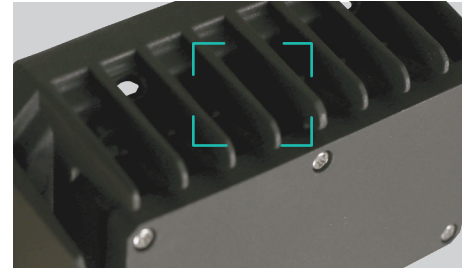

ADVANCED HEATSINK
Advanced heatsink allows for maximum cooling, prolonging life of the fixture.

DIMENSION

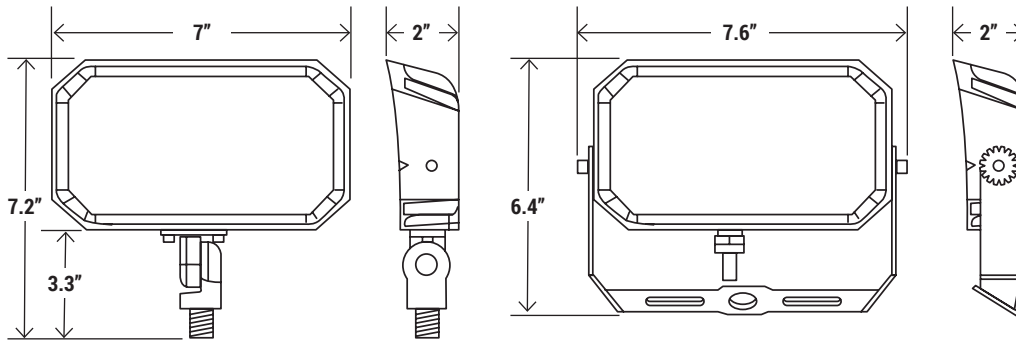

PHOTOMETRY

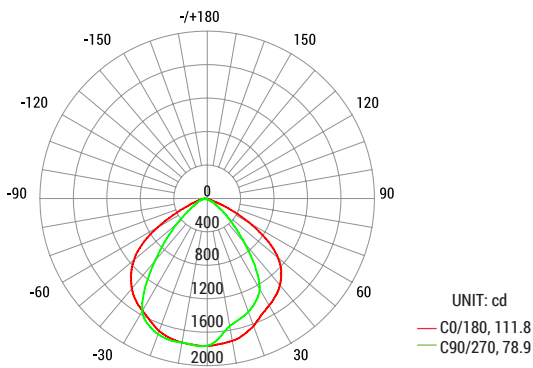

Average Beam Angle (50%) : 95.4 degree

OPTION



PT-FLM1-A-JB
Mini Floodlight Junction Box for
Knuckle Mounting Option

**Actual fixture not included*