

Project Name:	Notes:	Date:	Type:
---------------	--------	-------	-------

DESCRIPTION

Portor's LED slim flat panel commercial-grade luminaire utilizes a light guide LED optical system to achieve superior performance, providing clear uniformity, high-energy efficiency and reduced glare in T-grid ceiling applications.

Ideal use for offices, conference rooms, schools/campuses, retail stores and the health care industry.

CONSTRUCTION

PMMA grade acrylic multi-layered lens, light guide LED technology and powder-coat paint extruded aluminum frame.

ELECTRICAL

Luminaire is built with the highest quality 100-277VAC drivers.

DRIVER

Easy access driver is fixed on the back of the panel.

OPTICAL SYSTEM

Robust PMMA lens designed to reduce glare and improve light distribution through precision formed lens optics.

DIMMING

0-10V dimmable standard

CERTIFICATION

ETL Listed, FCC, RoHS

TECHNICAL SPECIFICATION

WATTAGE	50W
LUMENS	6,450 lumens
EFFICACY	129 lm/W
VOLTAGE	AC100-277V
POWER FREQUENCY	50/60 Hz
CCT	4000K
CRI	Ra>80
BEAM ANGLE	120°
WORKING TEMP.	-4°F - +113°F
IP RATING	IP44 Suitable for damp locations
DIMMABLE	0-10V dimming
POWER FACTOR	>0.9
THD	≤15%
WARRANTY	5 year limited
PORTOR CAT#	PT-FPA-24/50W-4K-P



MODEL NUMBER(S)

MODEL#	WATTS	LUMENS	LM/WATT	CCT	CRI	VOLTAGE
24AP5040A	50W	6,450	129	4000K	>80	AC 100/277V
24AP5050A	50W	6,475	130	5000K	>80	AC 100/277V

Project Name:	Notes:	Date:	Type:
---------------	--------	-------	-------

DIMENSION

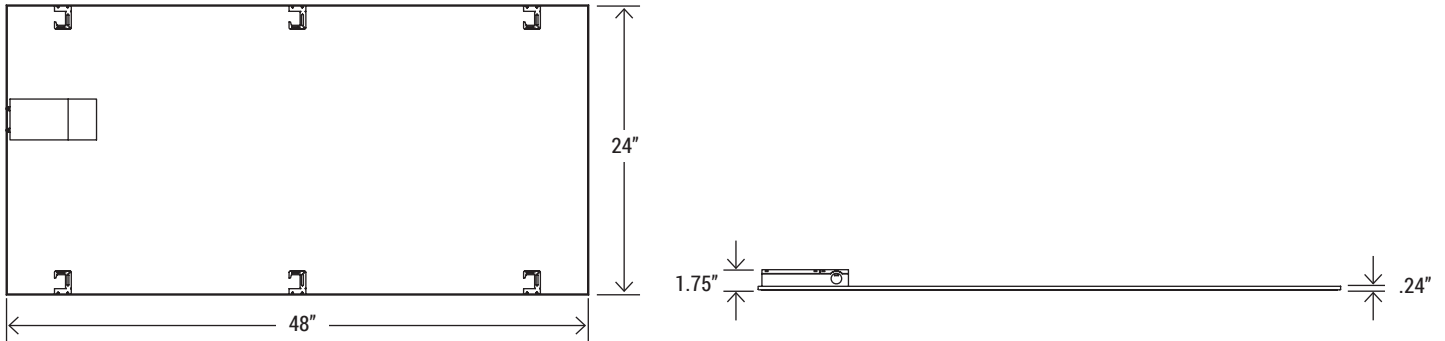

Maintenance-free optical module sealed for life; no internal cleaning required.

OPTION



EMERGENCY BATTERY BACK-UP
(Consult factory for more info)

PHOTOMETRY

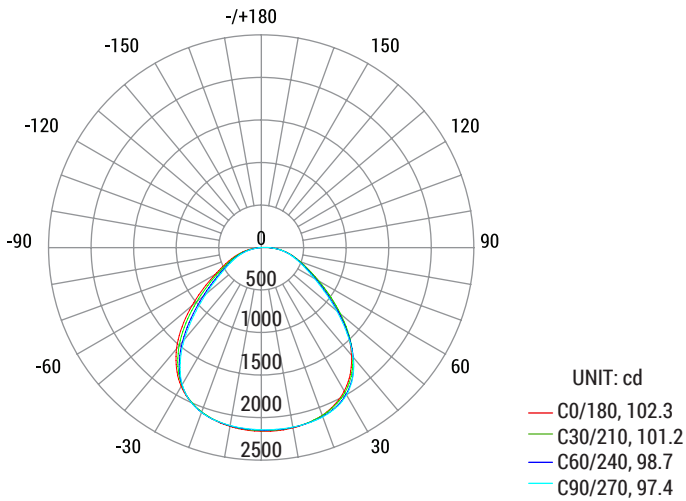

Average Beam Angle (50%) : 99.9 degree