

Project Name:	Notes:	Date:	Type:
---------------	--------	-------	-------

DESCRIPTION

The HBU1 High bay fixture is efficient, durable, and designed to withstand harsh conditions with its remarkable heat dissipation, dust-tight body, and resistance to water.

Ideal for indoor and outdoor areas, including gymnasiums, warehouses, retail spaces, and convention centers.



CONSTRUCTION

Advanced die-cast aluminum heat sink which provides excellent thermal transfer to extend component life. Built rugged for indoor and waterproof. Fixture comes standard with ring for suspended mounting.

ELECTRICAL

Luminaire is built with the highest quality universal 100-277VAC drivers.

OPTICAL SYSTEM

Honey comb diode design to reduces glare and improve light distribution.

LENS

With tempered clear glass lens.

SENSOR READY

On/Off Motion sensor.

CERTIFICATION

FCC, RoHS, CE, IP65 Rated for Wet Location

TECHNICAL SPECIFICATION

WATTAGE	300W
LUMENS	40,500 lumens
EFFICACY	130 lm/W
VOLTAGE	AC100-277V
POWER FREQUENCY	50/60 Hz
CCT	5000K (other CCT custom order)
CRI	Ra>70
BEAM ANGLE	120°
WORKING TEMP.	-40°F - +122°F
STORAGE TEMP.	-40°F - +158°F
IP RATING	IP65 Wet Location
DIMMABLE	0-10V dimming
POWER FACTOR	>0.95
THD	≤10%
WARRANTY	5 year limited



MODEL NUMBER(S)						
MODEL#	WATTS	LUMENS	LM/WATT	CCT	CRI	VOLTAGE
PT-HBU1-100W-5K	100W	13,500	130	5000K	>70	AC 100/277V
PT-HBU1-150W-5K	150W	20,250	130	5000K	>70	AC 100/277V
PT-HBU1-200W-5K	200W	27,000	130	5000K	>70	AC 100/277V
PT-HBU1-240W-5K	240W	36,445	130	5000K	>70	AC 100/277V
PT-HBU1-300W-5K	300W	40,500	130	5000K	>70	AC 100/277V

Project Name:	Notes:	Date:	Type:
---------------	--------	-------	-------

DIMENSION

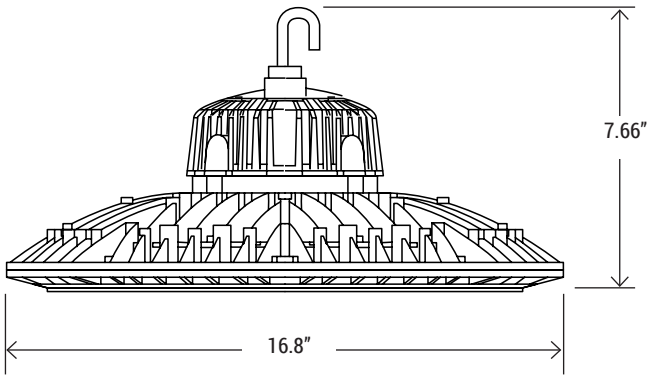

HONEY COMB DIODE TECHNOLOGY

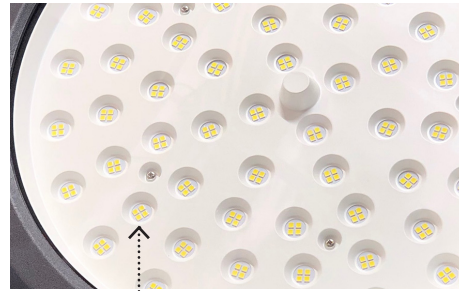

Honey comb reflector technology design increases light output up to 15%

AVAILABLE OPTIONS



PT-A-EMU-25W
Emergency LED
Driver For Round
High Bay



PT-A-MSH-C
Dimmable Microwave
Motion Sensor



PT-A-MSH-00-C
ON / OFF Microwave
Motion Sensor



PT-HBU1-A-UB
U-Bracket Mounting

PHOTOMETRY

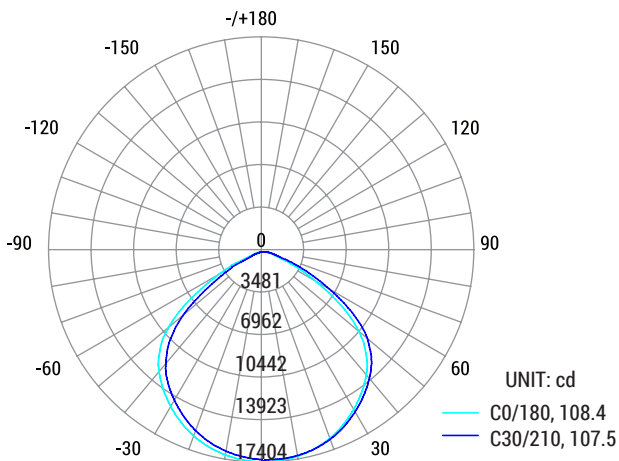

Average Beam Angle (50%) : 107.9 degree