

# INSTALLATION INSTRUCTIONS

## PT-VT2 SERIES

PT-VT2-2F / PT-VT2-4F / PT-VT2-8F

**PORTOR**  
LIGHTING  
a PORTOR INDUSTRY brand



### WARNING

- TO REDUCE THE RISK OF DEATH, PERSONAL INJURY OR PROPERTY DAMAGE FROM FIRE, ELECTRIC SHOCK, FALLING PARTS, CUTS/ABRASIONS, AND OTHER HAZARDS READ ALL WARNINGS AND INSTRUCTIONS INCLUDED WITH AND ON THE FIXTURE BOX AND ALL FIXTURE LABELS.
- BEFORE INSTALLING, SERVICING, OR PERFORMING ROUTINE MAINTENANCE UPON THIS EQUIPMENT, FOLLOW THESE GENERAL PRECAUTIONS.
- COMMERCIAL INSTALLATION, SERVICE AND MAINTENANCE OF LUMINAIRES SHOULD BE PERFORMED BY A QUALIFIED LICENSED ELECTRICIAN.
- **FOR THE INSTALLATION:** IF YOU ARE UNSURE ABOUT THE INSTALLATION OR MAINTENANCE OF THE LUMINAIRES, CONSULT A QUALIFIED LICENSED ELECTRICIAN AND CHECK YOUR LOCAL ELECTRICAL CODE.
- TO PREVENT WIRING DAMAGE OR ABRASION, DO NOT EXPOSE WIRING TO EDGES OF SHEET METAL OR OTHER SHARP OBJECTS.
- DO NOT MAKE OR ALTER ANY OPEN HOLES IN AN ENCLOSURE OF WIRING OR ELECTRICAL COMPONENTS DURING KIT INSTALLATION.

### GENERAL WIRING DIAGRAM

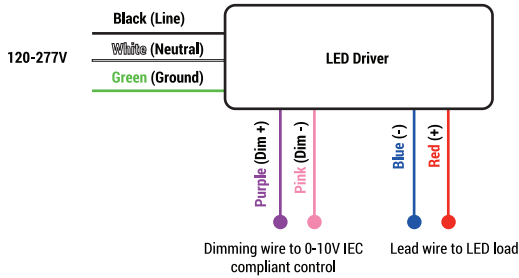

### WARNING

- TURN OFF ELECTRICAL POWER AT FUSE OR CIRCUIT BREAKER BOX BEFORE WIRING FIXTURE TO THE POWER SUPPLY.
- TURN OFF THE POWER WHEN YOU PERFORM ANY MAINTENANCE.
- VERIFY THAT SUPPLY VOLTAGE IS CORRECT BY COMPARING IT WITH THE LUMINAIRE LABEL INFORMATION.
- ALL WIRING CONNECTIONS SHOULD BE CAPPED WITH UL APPROVED WIRE CONNECTORS.

### CAUTION

- AVOID DIRECT EYE EXPOSURE TO THE LIGHT SOURCE WHILE IT IS ON.
- ACCOUNT FOR SMALL PARTS AND DESTROY PACKING MATERIAL, AS THESE MAY BE HAZARDOUS TO CHILDREN.
- **RISK OF BURN.** DISCONNECT POWER AND ALLOW FIXTURE TO COOL BEFORE CHANGING BULB OR HANDLING FIXTURE.

### NOTICE

- GREEN GROUND SCREW PROVIDED IN PROPER LOCATION. DO NOT RELOCATE.
- MINIMUM 90° SUPPLY CONDUCTORS.
- SPECIFICATIONS SUBJECT TO CHANGE WITHOUT NOTICE.
- SUITABLE FOR WET LOCATION.

## INSTALLATION (ALWAYS TURN OFF THE POWER SUPPLY FROM MAIN CIRCUIT BREAKER FIRST!)

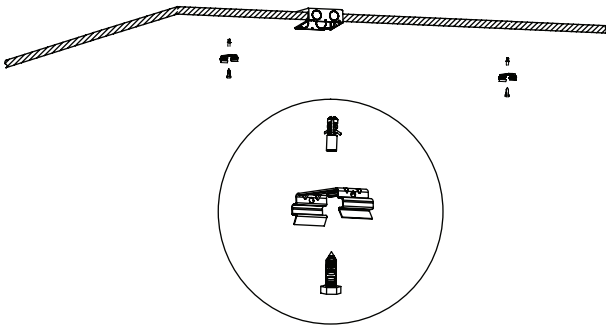

1. Locate drill holes for mounting brackets. Use hardware found in hardware kit. Mount bracket to surface.

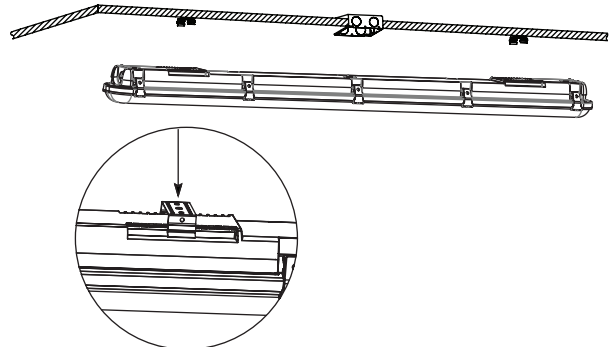

2. Secure mounting clips to housing recesses by firmly pressing them into place until both sides of the clip are secured.

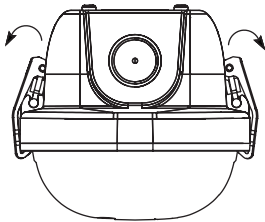

3. Release latches by pulling top of latch away from housing.

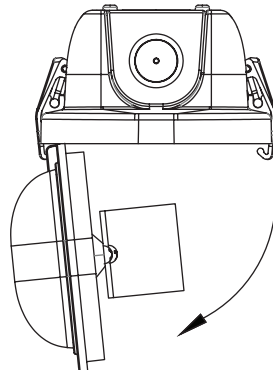

4. Without touching LED boards, detach LED tray and lens from fixture.

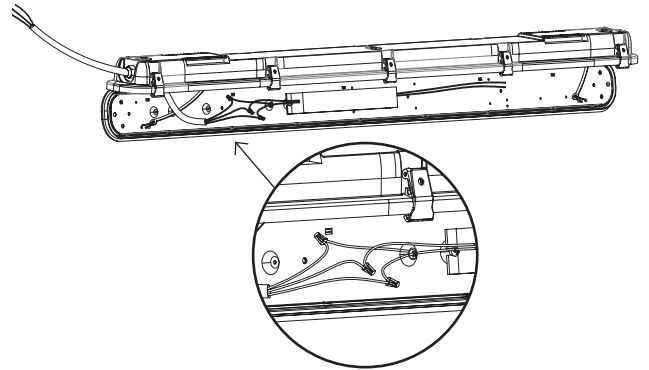

5. Connect power to driver as shown in the figure. (the flexible cord supplied by others)

**INSTALLATION** (ALWAYS TURN OFF THE POWER SUPPLY FROM MAIN CIRCUIT BREAKER FIRST!)

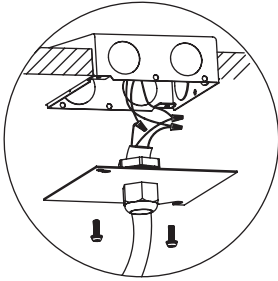
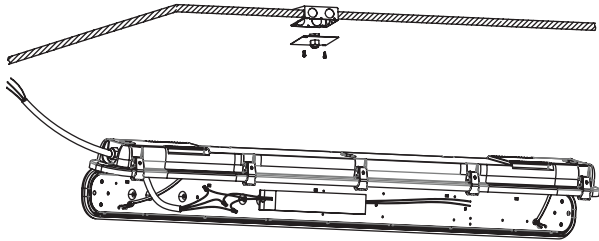

6. Connect power to driver through outlet box as shown (the flexible cord supplied by others), make sure to snap the cover to the outlet box after the wiring. Follow general wiring diagram for reference. Make sure the power supply is disconnected before installing.

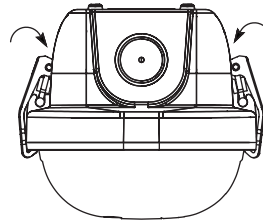

7. Re-attach LED tray to fixture by reversing step 3.

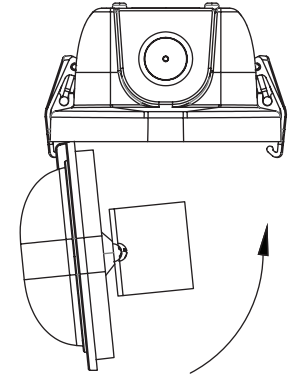

8. Install lens by using the buckles provided in hardware kit to secure attach lens to body fixture.

**CCT**  
SELECTABLE

**WATTAGE**  
SELECTOR

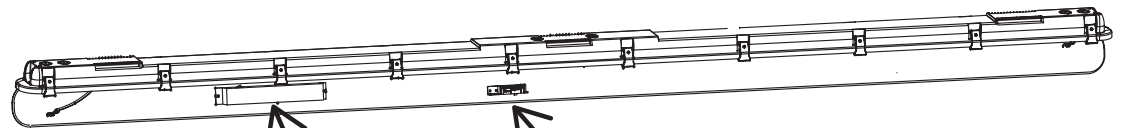

PT-VT2-8F

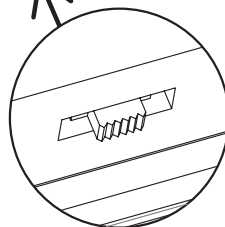

Wattage Switch

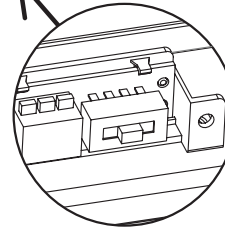

CCT Switch

The end users may adjust the color temperature and lumen output respectively by the two DIP switch. Each DIP switch is accommodated with 3 options (left, middle and right), corresponding to 3 color temperatures and 3 powers respectively, which can perform the desired color temperature and lumen output combination.

1. DIP switches are located onto the side of the fixture.
2. Select a wattage and color temperature by sliding switch left or right respectively to the desired value.

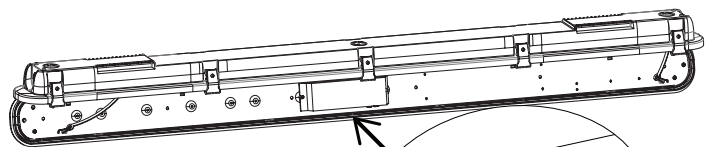

PT-VT2-2F / PT-VT2-4F

