

# INSTALLATION INSTRUCTIONS

## PT-AL2-3P SERIES

(100W/125W/150W) (240W/270W/300W)

WATTAGE  
**3W**  
SELECTOR



### READ THESE INSTRUCTIONS COMPLETELY AND CAREFULLY

- TO REDUCE THE RISK OF DEATH, PERSONAL INJURY OR PROPERTY DAMAGE FROM FIRE, ELECTRIC SHOCK, FALLING PARTS, CUTS/ABRASIONS, AND OTHER HAZARDS, PLEASE READ ALL WARNINGS AND INSTRUCTIONS INCLUDED WITH AND ON THE FIXTURE, BOX, AND ALL FIXTURE LABELS.
- BEFORE INSTALLING, SERVICING, OR PERFORMING ROUTINE MAINTENANCE ON THIS EQUIPMENT, FOLLOW THESE GENERAL PRECAUTIONS:
- INSTALLATION AND SERVICE OF LUMINAIRES SHOULD BE PERFORMED BY A QUALIFIED LICENSED ELECTRICIAN.
- MAINTENANCE OF THE LUMINAIRES SHOULD BE PERFORMED BY PERSON(S) FAMILIAR WITH THE LUMINAIRE'S CONSTRUCTION AND OPERATION, AND ANY HAZARDS INVOLVED. REGULAR FIXTURE MAINTENANCE PROGRAMS ARE RECOMMENDED.
- IT WILL OCCASIONALLY BE NECESSARY TO CLEAN THE OUTSIDE OF THE LENS. FREQUENCY OF CLEANING WILL DEPEND ON AMBIENT DIRT LEVEL AND MINIMUM LIGHT OUTPUT WHICH IS ACCEPTABLE TO USER. LENS SHOULD BE WASHED IN A SOLUTION OF WARM WATER AND ANY MILD, NON-ABRASIVE HOUSEHOLD DETERGENT, RINSED WITH CLEAN WATER AND WIPED DRY.
- SHOULD OPTICAL ASSEMBLY BECOME DIRTY ON THE INSIDE, WIPE LENS AND CLEAN IN ABOVE MANNER, REPLACING DAMAGED GASKETS AS NECESSARY.
- **DO NOT INSTALL DAMAGED PRODUCT!** THIS LUMINAIRE HAS BEEN PROPERLY PACKED SO THAT NO PARTS SHOULD HAVE BEEN DAMAGED DURING TRANSIT. INSPECT TO CONFIRM. ANY PART DAMAGED OR BROKEN DURING OR AFTER ASSEMBLY SHOULD BE REPLACED.

### WARNING RISK OF ELECTRIC SHOCK

- Turn off power before installation or servicing.
- Verify that supply voltage is correct by comparing it with the luminaire label information or wiring diagram.
- Make sure all electrical and grounded connections in accordance with the National Electrical Code (NEC) and local code requirements.
- All wiring connections should be capped with UL approved recognized wire connectors.

### WARNING RISK OF BURN

- Allow fixture to cool before handling. Do not touch enclosure or light source.
- Do not exceed maximum wattage marked on luminaire label.
- Follow all manufacturer's warnings, recommendations, and restrictions for: driver type, burning position, mounting locations/methods, replacement and recycling.

### WARNING RISK OF INJURY

- Wear gloves and safety glasses at all times when removing, installing, servicing or performing maintenance.
- Avoid direct eye exposure to the light source when fixture is on.

### WARNING RISK OF FIRE

- Keep combustible and other materials that can burn, away from lamp/lens.
- Do not operate in close proximity to persons, combustible materials, or substances affected by heat or drying.

## INSTALLATION (ALWAYS TURN OFF THE POWER SUPPLY FROM MAIN CIRCUIT BREAKER FIRST!)

### WIRING DIAGRAM

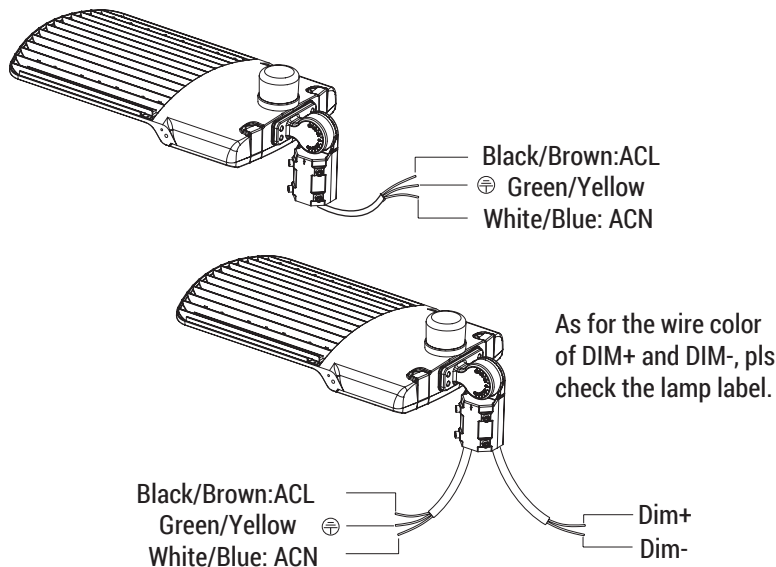

### MOUNTING OPTIONS (SOLD SEPARATELY)

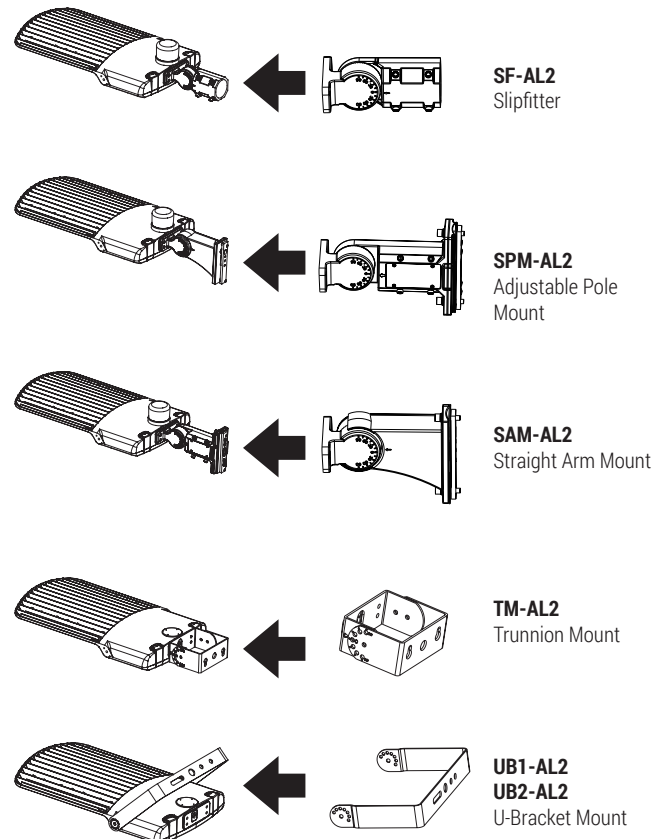

### EASILY FLIP THE SWITCH FOR DESIRED WATTAGE BEFORE INSTALLATION

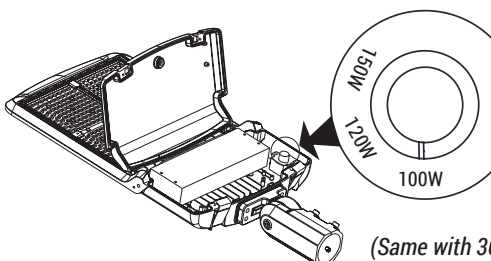

1. Open the driver box cover as shown in the figure, and find the wattage adjusting knob.
2. Close the driver box cover after finished adjustment.

(Same with 300W/270W/240W)

### INSTALLATION (CONTINUATION)

#### SLIPFITTER (SF):

**Step 1:**

Remove the bracket mounting screws on the fixture and run the wires through the bracket. (Figure 1)

**Step 2:**

Install the bracket on the fixture. (Figure 2)

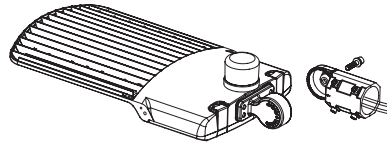

FIGURE 1

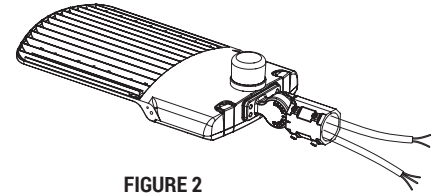

FIGURE 2

#### ADJUSTABLE POLE MOUNT (SPM):

**Step 1:**

Remove the bracket mounting screws on the fixture. Open the side lid of the bracket and run the wires through the bracket. (Figure 3)

**Step 2:**

Install the bracket on the fixture, then cover the side lid and tighten it. (Figure 4)

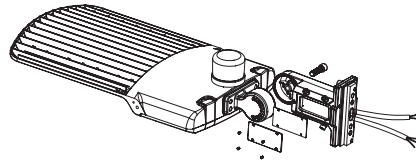

FIGURE 3

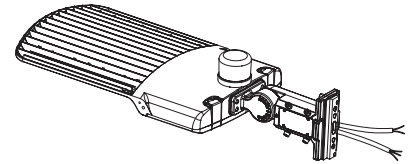

FIGURE 4

#### STRAIGHT ARM MOUNT (SAM):

**Step 1:**

Remove the bracket mounting screws on the fixture. Open the side lid of the bracket and run the wires through the bracket. (Figure 5)

**Step 2:**

Install the bracket on the fixture, then cover the side lid and tighten it. (Figure 6)

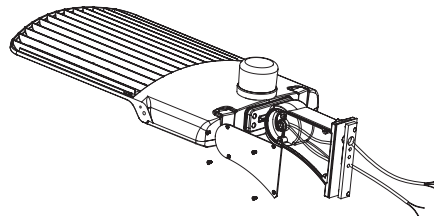

FIGURE 5

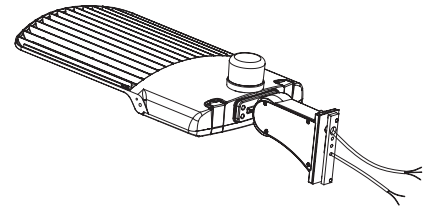

FIGURE 6

#### TRUNNION MOUNT (TM):

**Step 1:**

Remove the bracket mounting screws on the fixture and run the wires through the bracket. (Figure 7)

**Step 2:**

Install the bracket on the fixture. (Figure 8)

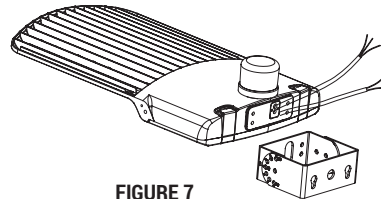

FIGURE 7

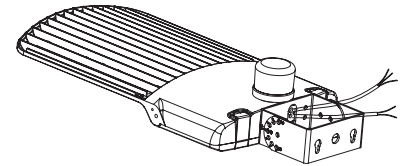

FIGURE 8

#### U-BRACKET MOUNT (UB):

**Step 1:**

First install two big screws (Figure 9)

**Step 2:**

Install two small screws. (Figure 10)

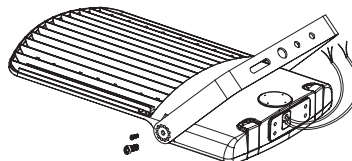

FIGURE 9

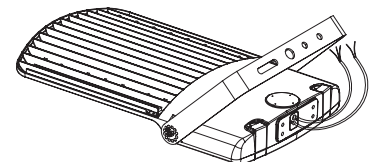

FIGURE 10