

Catalog Number:	Note:
Project Name:	Type:

INDUSTRIAL AND HIGH-COMMERCIAL LIGHTING MANUFACTURER

CLFL1 Series

Flood Light LED Luminaire

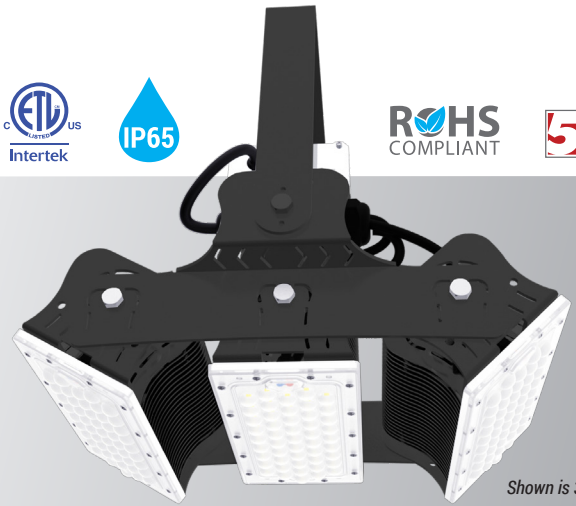

Shown is 300W

The CLFL series is IP65 rated and can be used indoors or outdoors, as it protects against water, dust, and vapor. Comes standard with surface mounting kit.

Ideal use for sports facilities, workshops, parking lots, warehouses, and a variety of other locations.

CONSTRUCTION

Excellent optical design, greatly improves the light utilization and evenness. The LED driver is mounted in direct contact with the casting to promote low operating temperature and long life. Aluminum cooling fin design for highly efficient heat dissipation.

ELECTRICAL

Luminaire is built with the highest quality 100-277VAC drivers.

OPTICAL SYSTEM

Designed to reduce glare and improve light distribution through precision formed lens optics.

MOUNTING

U-bracket mounting included.

ENERGY SAVINGS

Over 50% energy savings than traditionally fluorescent fixtures, low heat productions requires less maintenance and operation cost.

LISTING

ETL Listed, IP65 Rated, RoHS

WARRANTY

5 year Limited Warranty

PART NO.	DELIVERED LUMENS	EFFICACY
CLFL1-100W	17,000 @ 5000K	170 lm/W
CLFL1-200W	34,000 @ 5000K	170 lm/W
CLFL1-300W	51,000 @ 5000K	170 lm/W
CLFL1-400W*	68,000 @ 5000K	170 lm/W
CLFL1-600W*	102,000 @ 5000K	170 lm/W

*(special order required)

TECHNICAL SPECIFICATION

CCT	5000K (3000K, 4000K special order required)
CRI	70+
BEAM ANGLE	30°, 60°, 90°
VOLTAGE	100V-277V
POWER FREQUENCY	50/60 Hz
POWER FACTOR	>0.95
THD	≤20%
TEMPERATURE RATED	-40°F ~ 140°F
IP RATING	IP65
WARRANTY	5 year limited

ORDERING SAMPLE:

CLFL1 Series	-	100W Wattage	-	50K CCT	-	90 Beam Angle
CLFL1 Flood Light Series		100W 200W 300W 400W* 600W*		50K - 5000K (3000K, 4000K special order required)		90 - 90° (Standard) 60 - 60° 30 - 30°

*(special order required)

Catalog Number:	Note:
Project Name:	Type:

INDUSTRIAL AND HIGH-COMMERCIAL LIGHTING MANUFACTURER

CLFL1 SERIES

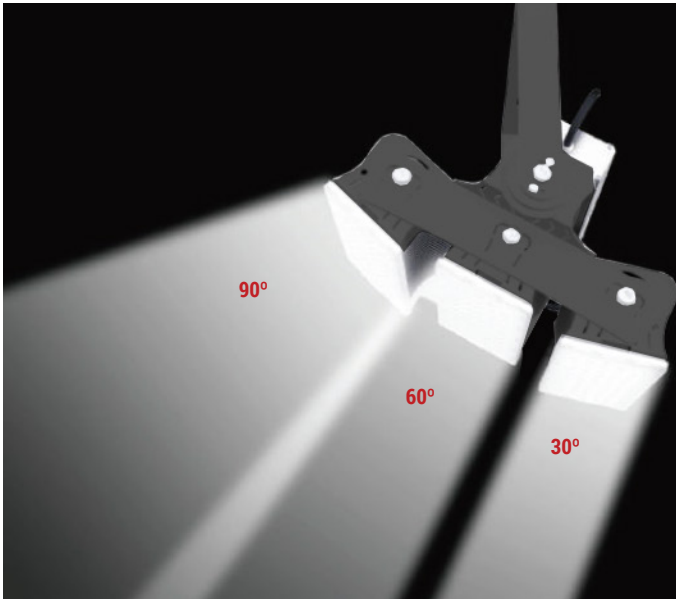

LIGHT DISTRIBUTION

Multiple optical lens choices are available with angles including 30°/60°/90° to meet the requirements for professional light distribution and an extensive scope of applications.



LED MODULE

Easy to replace, remove, maintain LED module.

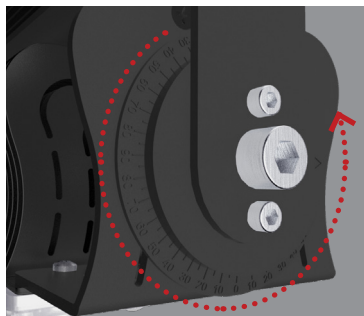
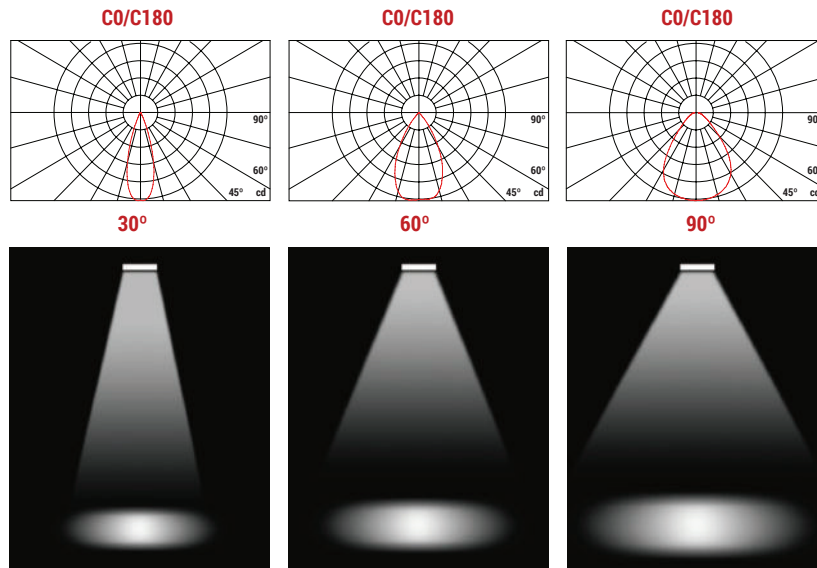

U-BRACKET

The U-bracket can be rotate up to 360°

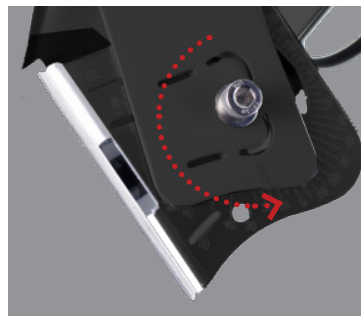

MODULE HOLDER

The module holder can be rotate up to 90°

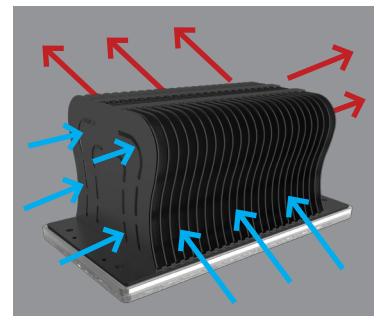

COOLING-FIN

Ultra-light weight, highly efficient heat-dissipation, multi-way air flow plus aluminum cooling-fin

Catalog Number:	Note:
Project Name:	Type:

INDUSTRIAL AND HIGH-COMMERCIAL LIGHTING MANUFACTURER

CLFL1 SERIES

DIMENSIONS

CLFL1-100W

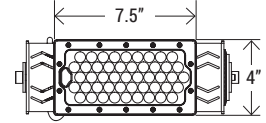
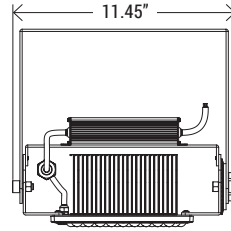
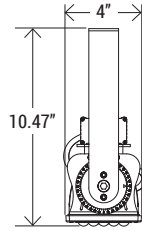

CLFL1-200W

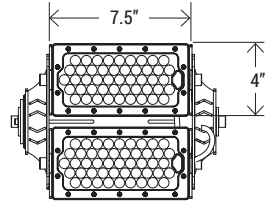
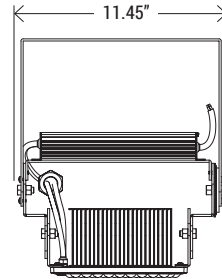
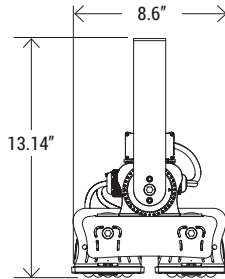

CLFL1-300W

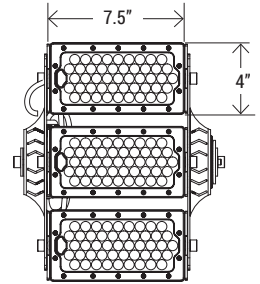
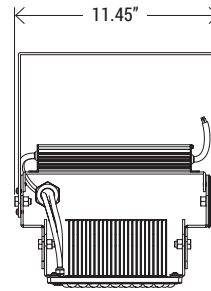
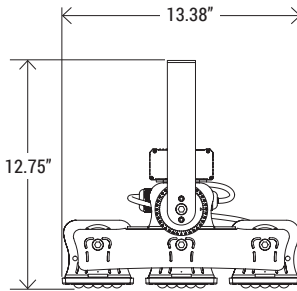

CLFL1-400W*

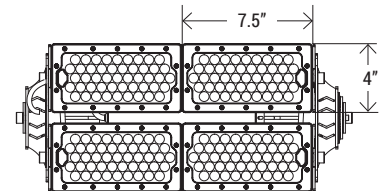
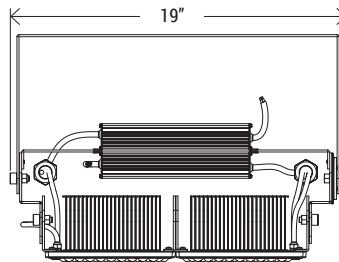
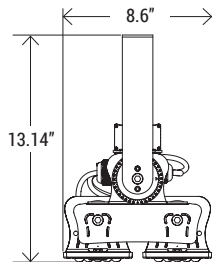

*(special order required)

CLFL1-600W*

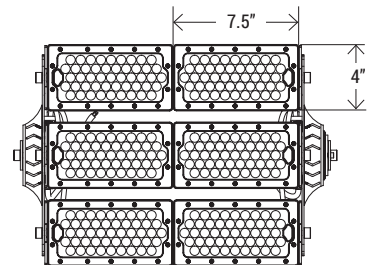
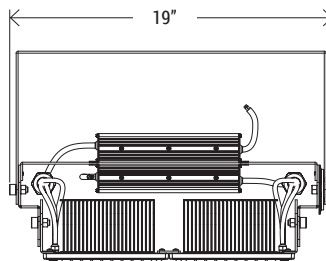
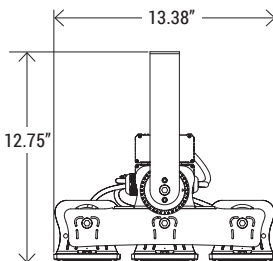

*(special order required)