

Catalog Number:	Project Name:	Note:	Date:	Type:
-----------------	---------------	-------	-------	-------

DESCRIPTION

The small but nimble FLM1 flood light series combines energy efficiency and advance optical control. The slim profile delivers enhanced lighting performance. Robust housing can withstand harsh outdoor environments.

Available with knuckle mount or a yoke mount for convenient mounting option. Ideal use for facades, outdoor, signage, shopping centers, industrial areas and other outdoor places with spot lighting is needed.



Knuckle Mount



Yoke Mount

CONSTRUCTION

Die-cast aluminum housing with excellent heat management equipped for long lasting durability. Weather-proof gasketed that is IP65 rated. Small slim profile make it versatile for various different application.

ELECTRICAL

Luminaire is built with the highest quality driver that is Universal Voltage (120-277V), uses long lasting, high-efficient LED packages. Flicker free, non-dimming.

OPTICAL SYSTEM

Compact rugged glass lens is designed to reduce glare and improve overall light-distribution through precision formed lens optics.

ENERGY SAVINGS

Over 50% energy savings than traditionally fluorescent fixtures, low heat productions requires less maintenance and operation cost.

LISTING

UL Listed, FCC, RoHS, CE, DLC Listed, IP65 rated with LM79 and LM80 report.

WARRANTY

5 year Limited Warranty, Rated for 50,000 hours. See Warranty documentation for details.

WATTAGE	DELIVERED LUMENS	EFFICACY
15W	1,800	120 lm/W
30W	3,600	120 lm/W
50W	6,000	120 lm/W

Based on 5000K, 70 CRI. Actual lumens may vary.

TECHNICAL SPECIFICATION

CCT	3000K, 5000K
CRI	70+
DIMMABLE	Non-dimming
BEAM ANGLE	80°x110°
VOLTAGE	120V-277V
POWER FREQUENCY	50/60 Hz
POWER FACTOR	>0.9
THD	≤15%
WORKING TEMPERATURE	-40°F - +113°F
STORAGE TEMPERATURE	-40°F - +158°F
IP RATING	IP65 Wet Location
WARRANTY	5 year limited



ORDERING SAMPLE: - - - - - -

Series	Wattage	Distribution	Mounting	CCT	Accessories/Options	
PT-FLM1 LED Mini Flood Series	15W 30W 50W	80X110 (80° x 110°)	K (Knuckle) Y (Yoke)	30K (3000K) 50K (5000K)	Junction Box	Photocell
					JB-FLM1	PSA

Catalog Number:	Project Name:	Note:	Date:	Type:
-----------------	---------------	-------	-------	-------

FEATURES

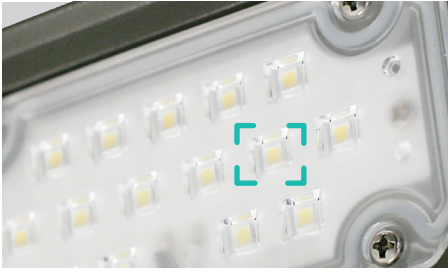

DISTRIBUTION LENS
1:1 lens to LED diode ratio, maximizing light distribution

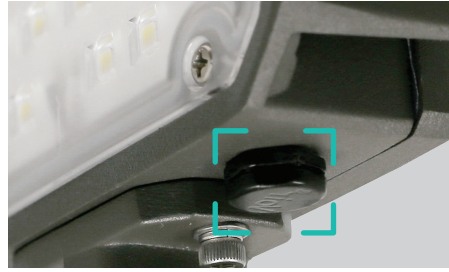

CONDENSATION VALVE
The FLM1 uses a state-of-the-art condensation valve, preventing water from collecting behind the lens.

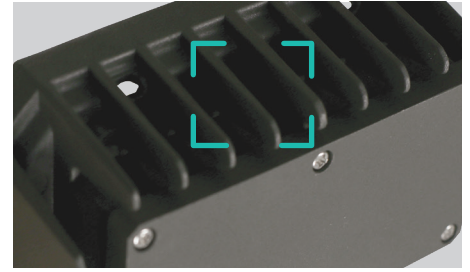

ADVANCED HEAT SINK
Advanced heat sink allows for maximum cooling, prolonging life of the fixture.

DIMENSION

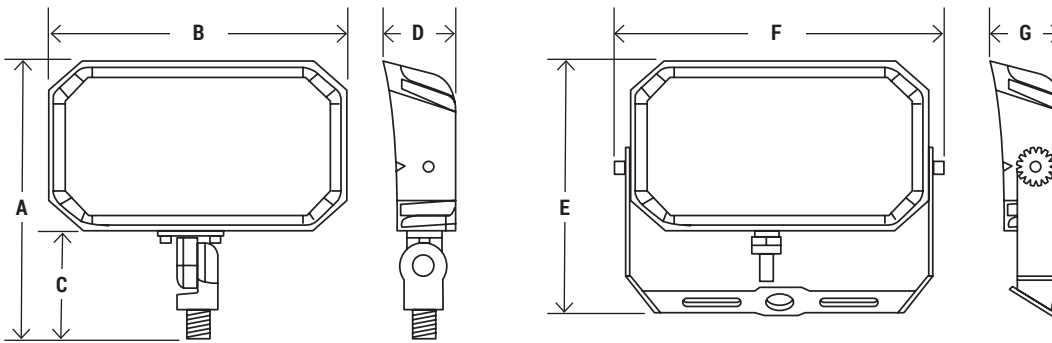

CATALOG NUMBER	A	B	C	D	E	F	G
PT-FLM1-15W	5.1"	6.1"	3.3"	1.8"	4.3"	5.7"	1.8"
PT-FLM1-30W	7.2"	7"	3.3"	2"	6.4"	7.6"	2"
PT-FLM1-50W	8.4"	9"	3.3"	2.3"	7.7"	9.8"	2.3"

JUNCTION BOX OPTION



JB-FLM1
Mini Floodlight Junction Box for Knuckle Mounting Option

**Actual fixture not included*

PHOTOCELL OPTION



PSA
Adjustable Photocell

Catalog Number:	Project Name:	Note:	Date:	Type:
-----------------	---------------	-------	-------	-------

PHOTOMETRY



Knuckle Mount



Yoke Mount



Knuckle Mount



Yoke Mount



Knuckle Mount



Yoke Mount

PT-FLM1-15W

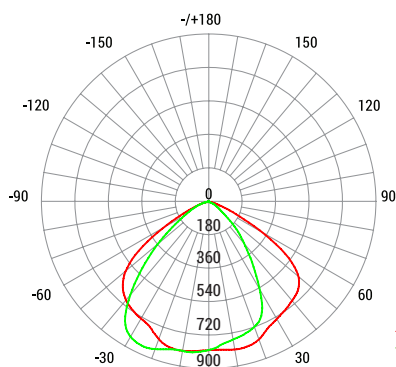

Average Beam Angle (50%) : 98.9 degree

PT-FLM1-30W

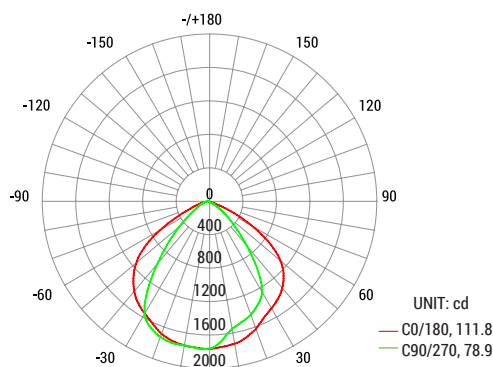

Average Beam Angle (50%) : 95.4 degree

PT-FLM1-50W

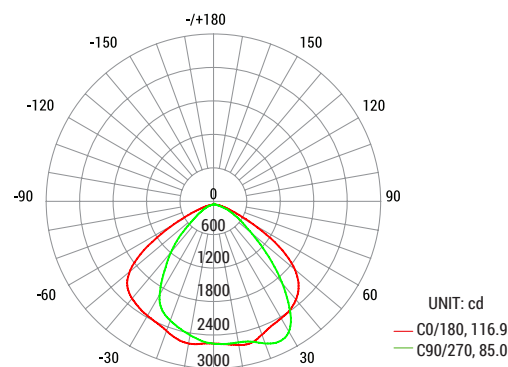

Average Beam Angle (50%) : 101.0 degree



DLC LISTING

CATALOG NUMBER	WATTAGE	DELIVERED LUMENS	EFFICACY	CCT	DLC PRODUCT ID
PT-FLM1-15W	15W	1,839	124 lm/W	3000K	P7Z0X619
		1,800	120 lm/W	5000K	PLQQ58YA0L95
PT-FLM1-30W	30W	3,982	129 lm/W	3000K	PQ30SE00
		3,600	120 lm/W	5000K	PL9TIAWX5159
PT-FLM1-50W	50W	6,567	130 lm/W	3000K	PT2P0YVB
		6,000	120 lm/W	5000K	PLDJ3K6RPLM2