

INSTALLATION INSTRUCTIONS

PT-DLSM2-S SERIES

PT-DLSM2-S-12I-22W-5CCT

PORTOR
LIGHTING
a PORTOR INDUSTRY brand

TUNABLE
5CCT
SELECTABLE
27K • 35K • 50K • 60K • 65K

SQUARE
SLIPFACE
MOUNT DOWNLIGHT

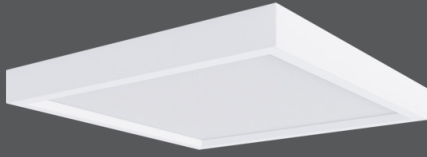

CAUTION: RISK OF ELECTRIC SHOCK

DISCONNECT POWER BEFORE CONNECTING THE FIXTURE. FAIL TO DO SO MAY PERMANENTLY DAMAGE THE LEDS.

WARNING

DO NOT REMOVE OR ATTEMPT TO REMOVE LEDS.





SAFETY PRECAUTIONS

FOR SAFETY, READ AND UNDERSTAND INSTRUCTIONS COMPLETELY BEFORE STARTING INSTALLATION. ELECTRICITY SHOULD BE TURNED OFF AT THE FUSE OR THE CIRCUIT BREAKER BOX BEFORE INSTALLING THE FIXTURE. ALL ELECTRICAL CONNECTIONS MUST BE IN ACCORDANCE WITH N. E. C. OR YOUR LOCAL CODE.

ASSEMBLY INSTRUCTIONS

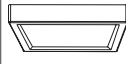
1. PREPARING FOR INSTALLATION: DISCONNECT ELECTRICAL POWER BEFORE INSTALLING OR SERVICING ANY PART OF THIS FIXTURE.
2. THIS PRODUCT SHALL BE SURFACE MOUNTED WITH JUNCTION BOX OR NON-COMBUSTIBLE SURFACE ABOVE 4 FEET (1.2 METER) HIGH. USER SHOULD PREPARE NECESSARY ACCESSORIES AND SPARE PARTS (NOT PROVIDED) INCLUDING JUNCTION BOX AND SCREWS.

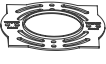
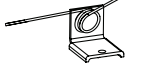
PACKAGE CONTENTS

A LED Surface Mount  (1 pc)	B Mounting screws  (2 pcs)	C Wire nuts  (3 pcs)	D Mounting plate  (1 pc)	E (Optional) Springs  (2 pcs)	G (Optional) E26 lamp holder  (1 pc)
--	---	--	---	--	---

INSTALLATION (CONSULT A QUALIFIED ELECTRICIAN BEFORE INSTALLING)

J-BOX INSTALLATION

1. Prior to installation, install mounting plate into the electrical outlet box with mounting screws. Drive screws completely to the end of the junction box.

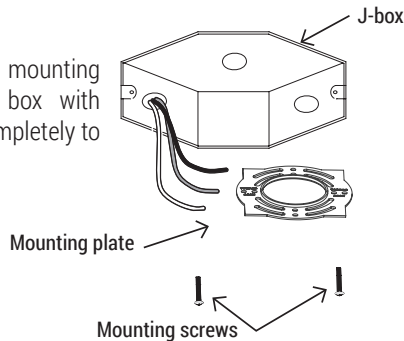

2. Connect supply wires to wires on fixture with wire nuts or push wires into Quick Connector. Connect white to white, black to black, and copper wire to copper wire as grounding connection.

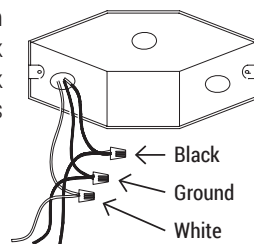

3. Completing the installation by pushing the fixture into the mounting plate

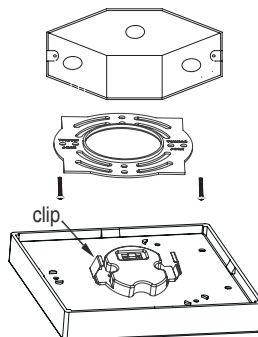

THIS LED LIGHT IS SUITABLE
TO BE DIMMED BY LUTRON #
CTCL-153P, PVCL-153P

RETROFIT OR RECESSED CAN INSTALLATION

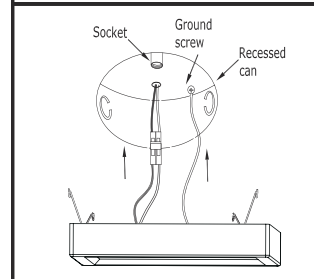
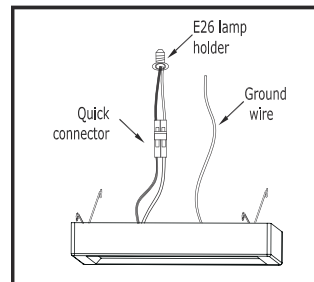

Insert wires into Quick connector. Black to black and white to white. Attach ground wire to ground screw in recessed can.

Turn E26 lamp holder into socket base.

Connect Quick Connectors. Tuck all wires into recessed can. Squeeze springs and push up into recessed can.

5 Inch Housing Position

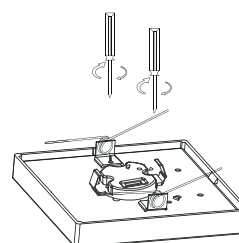

6 Inch Housing Position

