

Catalog Number:	Project Name:	Note:	Date:	Type:
-----------------	---------------	-------	-------	-------

Upgrades existing 2'x4' fluorescent troffers or louvers to LED with our reliable LED troffer retrofit kit fully assembled within the frame. With field-adjustable, and can be programmed with a CCT of 3500K, 4000K, or 5000K, eliminating the need to stock multiple color temperatures.

Ideal use for office spaces, walkways, schools/campuses, shopping centers, hospitality and health care industry.

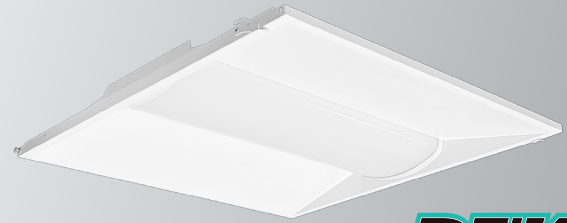

**CONSTRUCTION**

Constructed of one-piece ribbed unitized housing and corners that interlock, preventing damage to luminaire. All sides and corners are turned in and hemmed, removing sharp edges for safe handling and installation.

**ELECTRICAL**

Luminaire is built with the highest quality 120-277VAC drivers.

**OPTICAL SYSTEM**

Designed to reduce glare and improve light distribution through precision formed lens optics.

**CONTROLS**

Option available for dimmers and occupancy sensors (consult factory) to maximize energy savings.

**LISTING**

UL Listed, RoHS

**WARRANTY**

5 Years Limited Warranty

WATTAGE	DELIVERED LUMENS	EFFICACY
25W	3,511	up to 145 lm/W
30W	4,150	
35W	4,753	

*Based on actual IES results @ 4000K setting. Actual lumens may vary.*

**TECHNICAL SPECIFICATION**

CCT	3500K/4000K/5000K
CRI	80
DIMMABLE	0-10V dimmable
BEAM ANGLE	120°
VOLTAGE	120V-277V, 50/60 Hz
MAX. CURRENT (A)	0.29mA
POWER FACTOR	>0.9
THD	≤20%
LIFETIME	L70 > 100,000 hours
WORKING TEMPERATURE	-40°F ~ 122°F
IP RATING	Suitable for damp locations
WARRANTY	5 year limited warranty
DLC PRODUCT ID	S-6YKRXR

ORDERING SAMPLE:  -  -  -  -  -  -  -

Series	Size	CCT/ Wattage	Style	Accessories/Options (Sold separately)			
PT-TRO	22 (2' x 2')	3CP (3500K/4000K/5000K) (25W/30W/35W)	RTK (Retrofit Kit)	Sensor	EM Battery	Mounting Kit	MC Cable
				___ blank PT-BT-6 PT-MS-21-BT-JB	___ blank PT-EM1-15W	SMK-TRO-22 FK-22	MC-5W-SC-6F MC-6W-SC-6F

Catalog Number:	Project Name:	Note:	Date:	Type:
-----------------	---------------	-------	-------	-------

**DIMENSION**

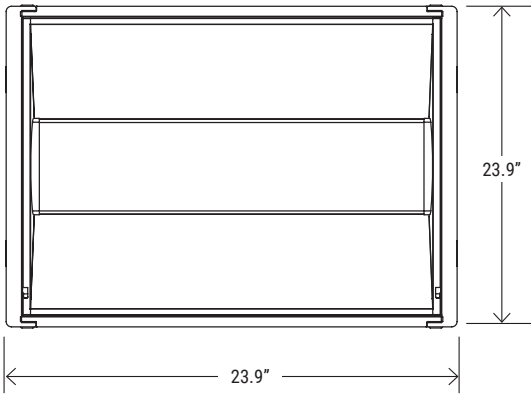

**QTY/CARTON**



Net Weight: **5.1 lbs**

Gross Weight: **6.4 lbs**

**MOTION SENSOR**



**EM OPTION**



**MOUNTING KIT**



**MC CABLES**

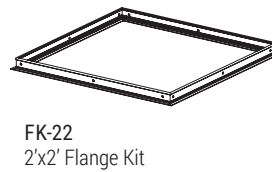

**PERFORMANCE**

WATTAGE	DELIVERED LUMENS	EFFICACY
25W	3,378 @ 3000K	135 lm/W
	3,511 @ 4000K	145 lm/W
	3,475 @ 5000K	138 lm/W
30W	3,973 @ 3000K	131 lm/W
	4,150 @ 4000K	143 lm/W
	4,086 @ 5000K	135 lm/W
35W	4,543 @ 3000K	128 lm/W
	4,753 @ 4000K	140 lm/W
	4,654 @ 5000K	131 lm/W

**WATTAGE AND CCT SELECTOR**

DEFAULT SETTING: **35W @ 5000K**

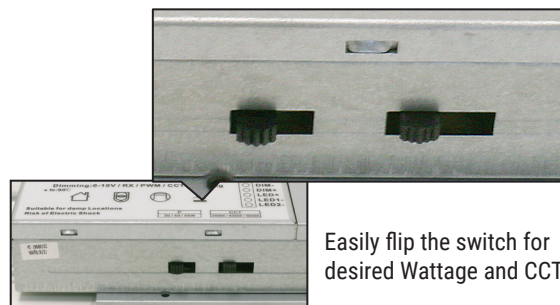

Easily flip the switch for desired Wattage and CCT.

