



READ THESE INSTRUCTIONS COMPLETELY AND CAREFULLY

- TO REDUCE THE RISK OF DEATH, PERSONAL INJURY OR PROPERTY DAMAGE FROM FIRE, ELECTRIC SHOCK, FALLING PARTS, CUTS/ABRASIONS, AND OTHER HAZARDS, PLEASE READ ALL WARNINGS AND INSTRUCTIONS INCLUDED WITH AND ON THE FIXTURE, BOX, AND ALL FIXTURE LABELS.
- BEFORE INSTALLING, SERVICING, OR PERFORMING ROUTINE MAINTENANCE ON THIS EQUIPMENT, FOLLOW THESE GENERAL PRECAUTIONS:
- INSTALLATION AND SERVICE OF LUMINAIRES SHOULD BE PERFORMED BY A QUALIFIED LICENSED ELECTRICIAN.
- MAINTENANCE OF THE LUMINAIRES SHOULD BE PERFORMED BY PERSON(S) FAMILIAR WITH THE LUMINAIRE'S CONSTRUCTION AND OPERATION, AND ANY HAZARDS INVOLVED. REGULAR FIXTURE MAINTENANCE PROGRAMS ARE RECOMMENDED.
- IT WILL OCCASIONALLY BE NECESSARY TO CLEAN THE OUTSIDE OF THE LENS. FREQUENCY OF CLEANING WILL DEPEND ON AMBIENT DIRT LEVEL AND MINIMUM LIGHT OUTPUT WHICH IS ACCEPTABLE TO USER. LENS SHOULD BE WASHED IN A SOLUTION OF WARM WATER AND ANY MILD, NON-ABRASIVE HOUSEHOLD DETERGENT, RINSED WITH CLEAN WATER AND WIPED DRY.
- SHOULD OPTICAL ASSEMBLY BECOME DIRTY ON THE INSIDE, WIPE LENS AND CLEAN IN ABOVE MANNER, REPLACING DAMAGED GASKETS AS NECESSARY.
- **DO NOT INSTALL DAMAGED PRODUCT!** THIS LUMINAIRE HAS BEEN PROPERLY PACKED SO THAT NO PARTS SHOULD HAVE BEEN DAMAGED DURING TRANSIT. INSPECT TO CONFIRM. ANY PART DAMAGED OR BROKEN DURING OR AFTER ASSEMBLY SHOULD BE REPLACED.

WARNING RISK OF ELECTRIC SHOCK

MIN 90 °C SUPPLY CONDUCTORS
THIS PRODUCT MUST BE INSTALLED IN ACCORDANCE WITH THE APPLICABLE INSTALLATION CODE BY A PERSON FAMILIAR WITH THE CONSTRUCTION AND OPERATION OF THE PRODUCT AND THE HAZARDS INVOLVED.
LES FILS D'ALIMENTATION 90 °C MIN
CE PRODUIT DOIT ETRE INSTALLE SE LON LE CODE D'INSTALLATION PERTINENT, PAR UNE PERSON NE QUI CONNAIT BIEN LE PRODUIT ET SON FONCTIONNEMENT AINSI QUE LES RISQUES INHERENTS.

WARNING RISK OF BURN

- Allow fixture to cool before handling. Do not touch enclosure or light source.
- Do not exceed maximum wattage marked on luminaire label.
- Follow all manufacturer's warnings, recommendations, and restrictions for: driver type, burning position, mounting locations/methods, replacement and recycling.

WARNING RISK OF INJURY

- Wear gloves and safety glasses at all times when removing, installing, servicing or performing maintenance.
- Avoid direct eye exposure to the light source when fixture is on.

WARNING RISK OF FIRE

- Keep combustible and other materials that can burn, away from lamp/lens.
- Do not operate in close proximity to persons, combustible materials, or substances affected by heat or drying.

INSTALLATION (ALWAYS TURN OFF THE POWER SUPPLY FROM MAIN CIRCUIT BREAKER FIRST!)

GENERAL WIRING DIAGRAM

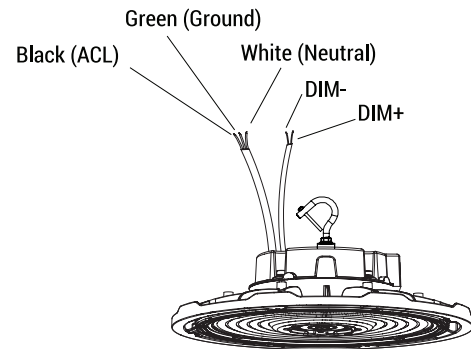
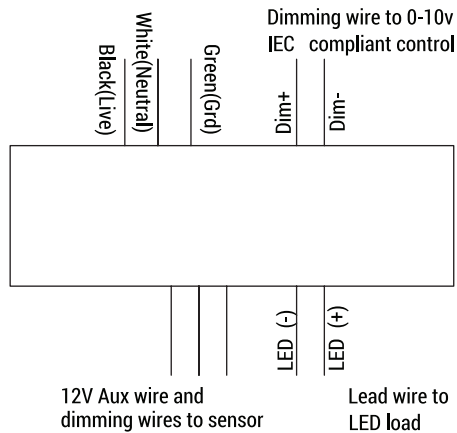

HOOK MOUNT:

1. Screw the hook into the fixture. tighten and fix it (Figure 1)
2. Hang the fixture on the ceiling hook or chain (Figure 2)
3. After installation, connect the wire of the fixture to the mains according to the local wiring rules, ensure the connection is stable and make good protection on the connection.

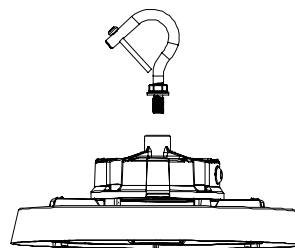

FIGURE 1

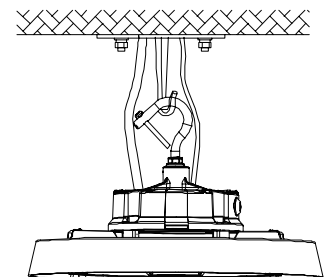

FIGURE 2

INSTALLATION (CONTINUATION)

CEILING MOUNT:

1. Mark with a mark pen or sharp tool on the mounting surface and drill (Figure 1).
2. Fix screw into the hole with a hammer (Figure 2).
3. Align the bracket hole with screw hole (Figure 3) and push the fixture to one side (Figure 4) and fix it.
4. After installation, connect the wire of the fixture to the mains according to local wiring rules, ensure the connection is stable and make good protection on connection.
By adjusting the brackets screws, user can adjust 50° to the left or right vertically (Figure 5).

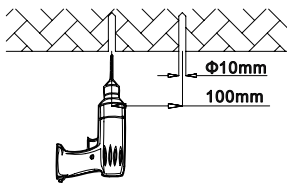

FIGURE 1

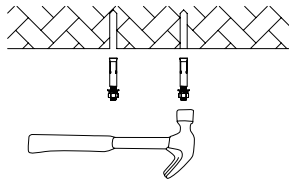

FIGURE 2

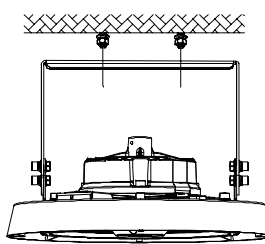

FIGURE 3

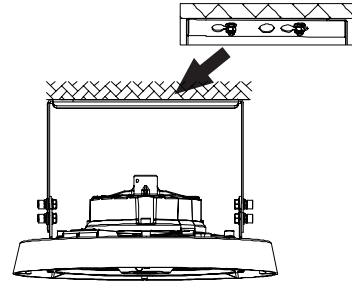

FIGURE 4

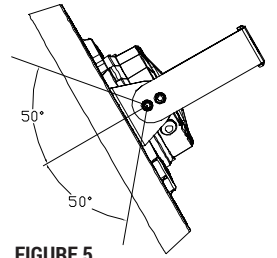

FIGURE 5

A) PENDANT MOUNT:

1. Unscrew the nuts on 1/2" NTP (Figure 1)
2. Insert 1/2" NTP stem into the bracket hole (Figure 2)
3. Re-screw the nuts (Figure 3)
4. After installation, connect the wire of the fixture to the mains according to local wiring rules, ensure the connection is stable and make good protection on connection.

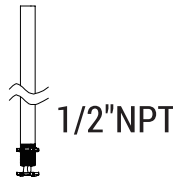

FIGURE 1

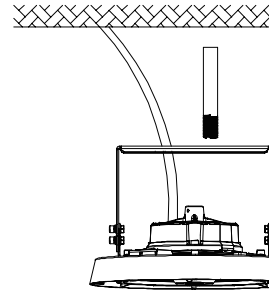

FIGURE 2

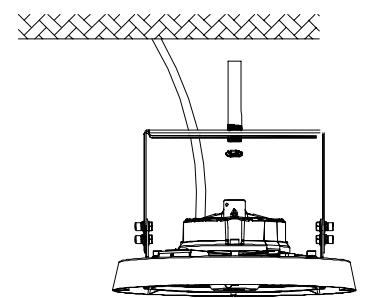
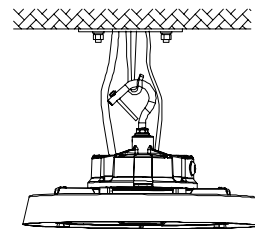

FIGURE 3

INSTALLATION OF DC MOTION SENSOR

If fixture has sensor receptacle installed, screw the 1/2" Knockout out with screw driver by illustrated direction, and screw the sensor kit on. The sensor is set as universal mode (refer to sensor spec sheet), the setting is programmable via remote control (the remote control is not included in standard packing)



Remove the 1/2" knockout

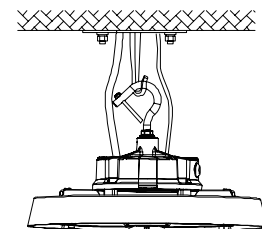

Install the motion sensor