

# INSTALLATION INSTRUCTIONS

PT-DL31-BL SERIES

PT-DL31-BL-4I-10W-5CCT

**PORTOR**  
LIGHTING  
a PORTOR INDUSTRY brand

4"  
APERTURE



**5CCT**  
SELECTOR  
27K • 30K • 35K • 40K • 50K

## CAUTION: RISK OF ELECTRIC SHOCK

DISCONNECT POWER BEFORE CONNECTING THE FIXTURE. FAIL TO DO SO MAY PERMANENTLY DAMAGE THE LEDS.

## WARNING

DO NOT REMOVE OR ATTEMPT TO REMOVE LEDS.

## SAFETY PRECAUTIONS

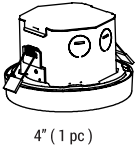
FOR SAFETY, READ AND UNDERSTAND INSTRUCTIONS COMPLETELY BEFORE STARTING INSTALLATION. ELECTRICITY SHOULD BE TURNED OFF AT THE FUSE OR THE CIRCUIT BREAKER BOX BEFORE INSTALLING THE FIXTURE. ALL ELECTRICAL CONNECTIONS MUST BE IN ACCORDANCE WITH N. E. C. OR YOUR LOCAL CODE.

## ASSEMBLY INSTRUCTIONS

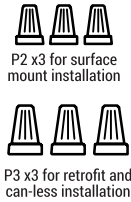
1. PREPARING FOR INSTALLATION: DISCONNECT ELECTRICAL POWER BEFORE INSTALLING OR SERVICING ANY PART OF THIS FIXTURE.
2. THIS DEVICE COMPLIES WITH PART 15 OF THE FCC RULES. OPERATION IS SUBJECT TO THE FOLLOWING TWO CONDITIONS: (1) THIS DEVICE MAY NOT CAUSE HARMFUL INTERFERENCE, AND (2) THIS DEVICE MUST ACCEPT ANY INTERFERENCE RECEIVED, INCLUDING THAT MAY CAUSE UNDESIRE OPERATION.

## PACKAGE CONTENTS

### A LED 3 in 1 Downlight



### B Wire nuts



### For surface mount

#### C Mounting bracket



#### D Junction box screw#8-32 (1-1/2 Screws x2)



#### E Junction box screw#8-32 (3/4 Screws x2)

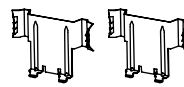


### For retrofit/recessed

#### F TP24 supply wire adapter



#### G Torsion spring x2



#### H M2x4 Screws x2

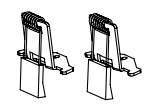


#### I E26 base adapter



### For can-less

#### J Spring clip x2

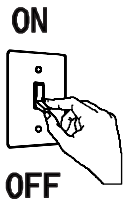


#### H M2x4 Screws x2

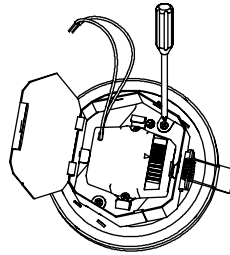


## INSTALLATION (CONSULT A QUALIFIED ELECTRICIAN BEFORE INSTALLING)

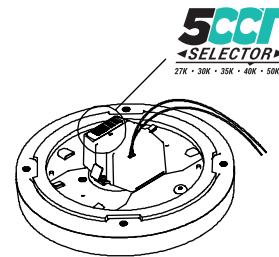
### SURFACE MOUNT INSTALLATION (Suitable for j-box with 4" round/square/octagonal with 1.5" depth)



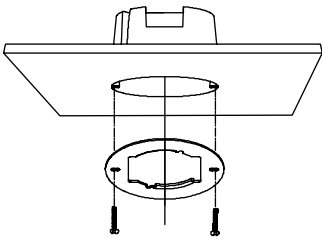
**Fig. 1**  
Turn off the power. Make sure the switch is OFF.



**Fig. 2**  
Remove the screws at both side of the junction box, and then take off the junction box.

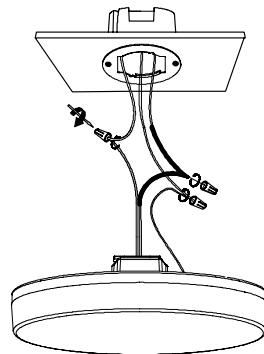


**Fig. 3**  
Toggle the button to adjust the CCT, total 5 CCT can be selected.



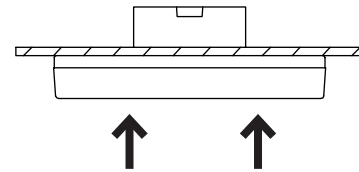
**Fig. 4**  
According to the embedded junction box to choose the screws (E or F)

Then, use screwdriver to lock the mounting bracket (C) to the embedded junction box with screws (E or F)



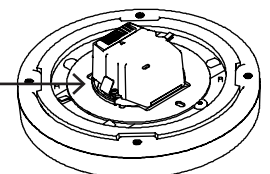
**Fig. 5**  
Firstly, choose the suitable wire nuts (B)

Then, use the wire nuts (B) to connect the wire in the embedded junction box with the wires on down light (black to black, white to white, green to green)



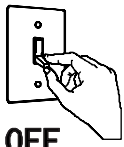
**Fig. 6**  
Push the downlight into the mounting bracket to complete the installation.

Make sure the clips will lock to the bracket.



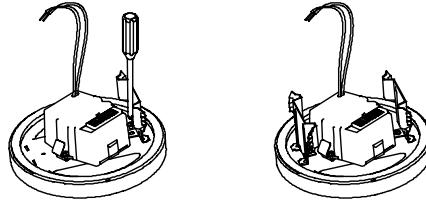
### RETROFIT INSTALLATION (Suitable for 4" retrofit housing)

ON

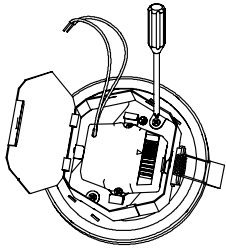


OFF

**Fig. 1**  
Turn off the power. Make sure the switch is OFF.

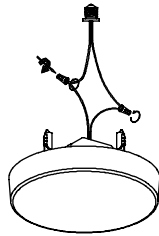


**Fig. 4**  
Install the torsion springs (G) as shown with the supplied screws (H).

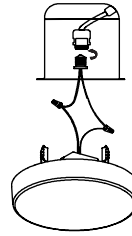


**Fig. 2**  
Remove the screws on both side of the junction box, and then take off the junction box.

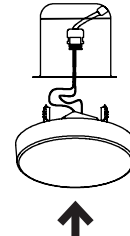
#### FOR E26 BASE ADAPTER



**Fig. 5**  
Connect the wire on E26 with the wires on downlight (black to black, white to white, if you have ground in the embedded housing, then make it green to green)

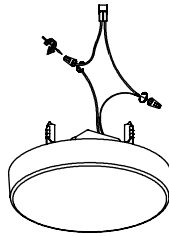


**Fig. 6**  
Connect the downlight into the embedded housing as shown.

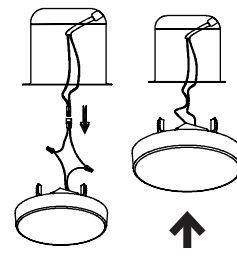


**Fig. 7**  
Push the downlight into the housing to complete the installation.

#### FOR TP24 SUPPLY WIRE ADAPTER

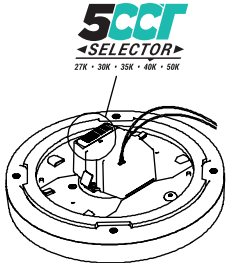


**Fig. 5**  
Connect the wire on the TP24 adapter (F) with the wires on downlight.



**Fig. 6**  
Connect the TP24 (F) which is already in the embedded housing.

Push the downlight to complete the installation.



**Fig. 3**  
Toggle the button to adjust the CCT, total 5 CCT can be selected.

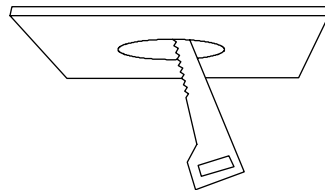
### CAN-LESS INSTALLATION (Use tools to cut holes in the ceiling - 4"/4.25", 6"/6.3")

ON

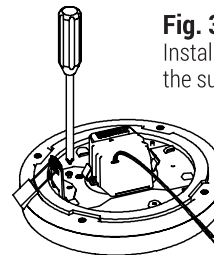


OFF

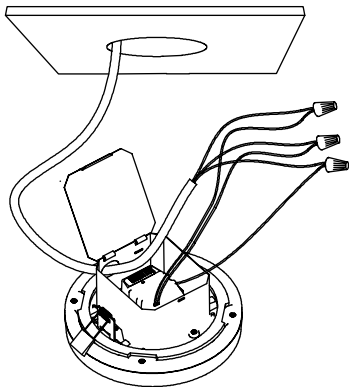
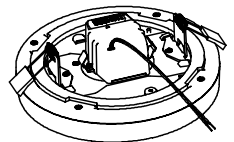
**Fig. 1**  
Turn off the power. Make sure the switch is OFF.



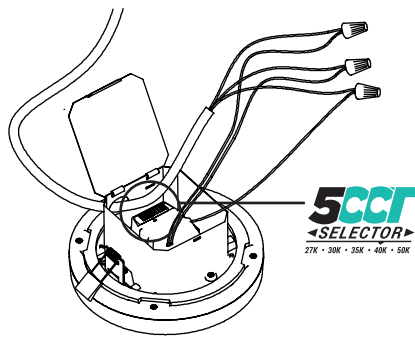
**Fig. 2**  
Cut holes in the ceiling for desired size.



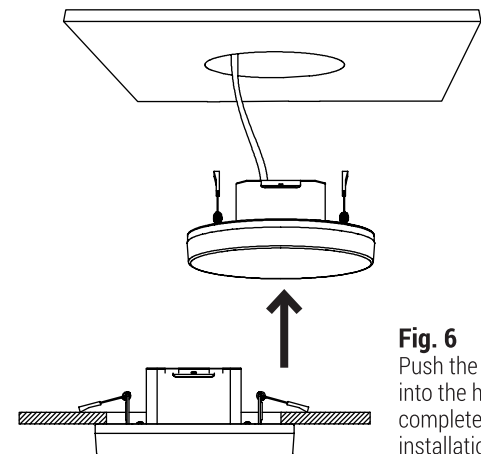
**Fig. 3**  
Install the springs clips (J) as shown with the supplied screws (H).



**Fig. 4**  
Connect the wires in the junction box (black to black, white to white, green to green).



**Fig. 5**  
Toggle the button to adjust the CCT, total 5 CCT can be selected.



**Fig. 6**  
Push the downlight into the hole to complete the installation.

# INSTALLATION INSTRUCTIONS

## PT-DL31-BL SERIES

PT-DL31-BL-6I-12W-5CCT

**PORTOR**  
LIGHTING  
a PORTOR INDUSTRY brand

6"  
APERTURE



**5CCT**  
SELECTOR  
27K • 30K • 35K • 40K • 50K

### CAUTION: RISK OF ELECTRIC SHOCK

DISCONNECT POWER BEFORE CONNECTING THE FIXTURE. FAIL TO DO SO MAY PERMANENTLY DAMAGE THE LEDS.

### WARNING

DO NOT REMOVE OR ATTEMPT TO REMOVE LEDS.

### SAFETY PRECAUTIONS

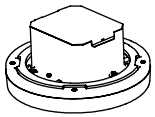
FOR SAFETY, READ AND UNDERSTAND INSTRUCTIONS COMPLETELY BEFORE STARTING INSTALLATION. ELECTRICITY SHOULD BE TURNED OFF AT THE FUSE OR THE CIRCUIT BREAKER BOX BEFORE INSTALLING THE FIXTURE. ALL ELECTRICAL CONNECTIONS MUST BE IN ACCORDANCE WITH N. E. C. OR YOUR LOCAL CODE.

## ASSEMBLY INSTRUCTIONS

1. PREPARING FOR INSTALLATION: DISCONNECT ELECTRICAL POWER BEFORE INSTALLING OR SERVICING ANY PART OF THIS FIXTURE.
2. THIS DEVICE COMPLIES WITH PART 15 OF THE FCC RULES. OPERATION IS SUBJECT TO THE FOLLOWING TWO CONDITIONS: (1) THIS DEVICE MAY NOT CAUSE HARMFUL INTERFERENCE, AND (2) THIS DEVICE MUST ACCEPT ANY INTERFERENCE RECEIVED, INCLUDING THAT MAY CAUSE UNDESIRE OPERATION.

## PACKAGE CONTENTS

### A LED 3 in 1 Downlight



6" (1 pc)

### B Wire nuts



P2 x3 for surface mount installation



P3 x3 for retrofit and can-less installation

### For surface mount

#### C Mounting bracket



#### D Junction box screw#8-32 (1-1/2 Screws x2)



#### E Junction box screw#8-32 (3/4 Screws x2)



### For retrofit/recessed

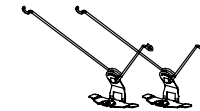
#### F TP24 supply wire adapter



#### H M2x4 Screws x2



#### G Torsion spring x2

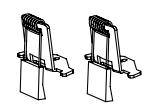


#### I E26 base adapter



### For can-less

#### J Spring clip x2

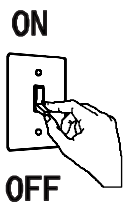


#### H M2x4 Screws x2

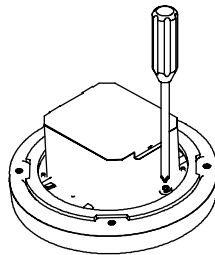


## INSTALLATION (CONSULT A QUALIFIED ELECTRICIAN BEFORE INSTALLING)

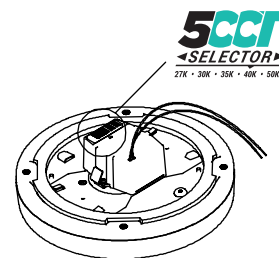
### SURFACE MOUNT INSTALLATION (Suitable for j-box with 4" round/square/octagonal with 1.5" depth)



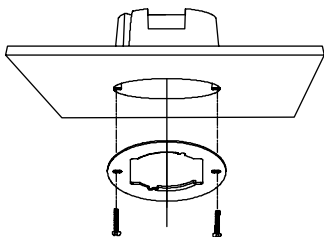
**Fig. 1**  
Turn off the power. Make sure the switch is OFF.



**Fig. 2**  
Remove the screws on both side of the junction box, and then take off the junction box.

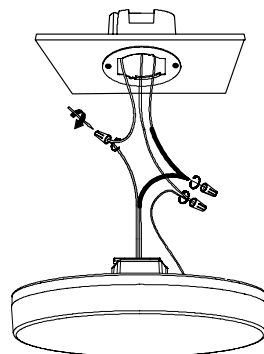


**Fig. 3**  
Toggle the button to adjust the CCT, total 5 CCT can be selected.



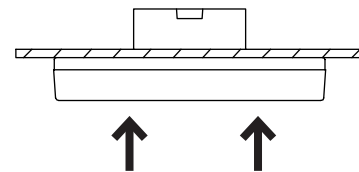
**Fig. 4**  
According to the embedded junction box to choose the screws (E or F)

Then, use screwdriver to lock the mounting bracket (C) to the embedded junction box with screws (E or F)



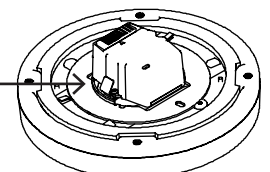
**Fig. 5**  
Firstly, choose suitable wire nuts (B).

Then, use the wire nuts (B) to connect the wire in the embedded junction box with the wires on down light (black to black, white to white, green to green)



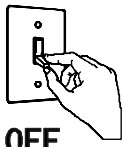
**Fig. 6**  
Push the downlight into the mounting bracket to complete the installation.

Make sure the clips will lock to the bracket.



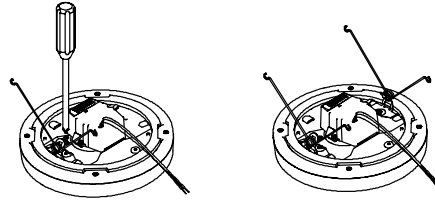
### RETROFIT INSTALLATION (Suitable for 5" or 6" retrofit housing)

ON



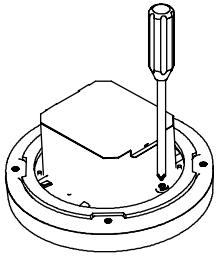
OFF

**Fig. 1**  
Turn off the power. Make sure the switch is OFF.

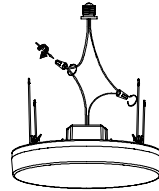


**Fig. 4**  
Install the torsion springs (G) as shown with the supplied screws (H).

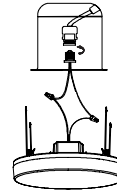
#### FOR E26 BASE ADAPTER



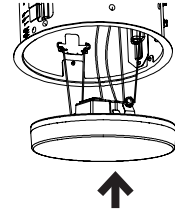
**Fig. 2**  
Remove the screws on both side of the junction box, and then take off the junction box.



**Fig. 5**  
Connect the wire on E26 with the wires on downlight (black to black, white to white, if you have ground in the embedded housing, then make it green to green)

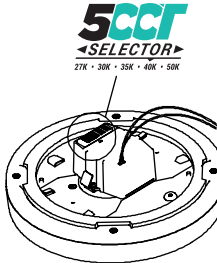


**Fig. 6**  
Connect the downlight into the embedded housing as shown.

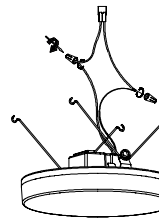


**Fig. 7**  
Push the downlight into the housing to complete the installation.

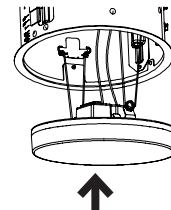
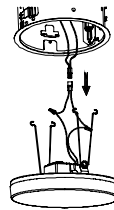
#### FOR TP24 SUPPLY WIRE ADAPTER



**Fig. 3**  
Toggle the button to adjust the CCT, total 5 CCT can be selected.



**Fig. 5**  
Connect the wire on the TP24 adapter (F) with the wires on downlight.

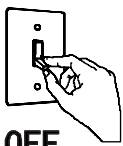


**Fig. 6**  
Connect the TP24 (F) which is already in the embedded housing.

Push the downlight to complete the installation.

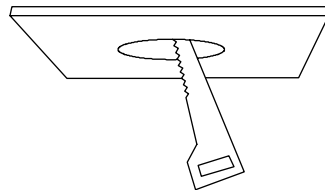
### CAN-LESS INSTALLATION (Use tools to cut holes in the ceiling - 4"/4.25", 6"/6.3")

ON

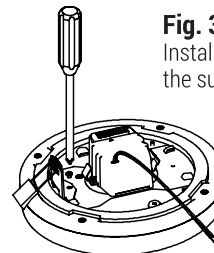


OFF

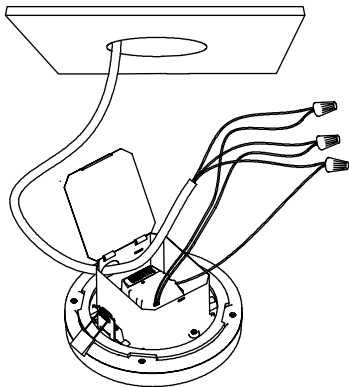
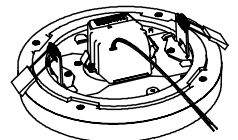
**Fig. 1**  
Turn off the power. Make sure the switch is OFF.



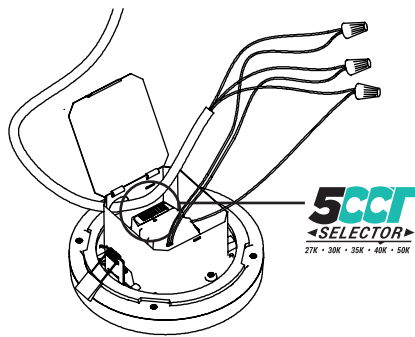
**Fig. 2**  
Cut holes in the ceiling for desired size.



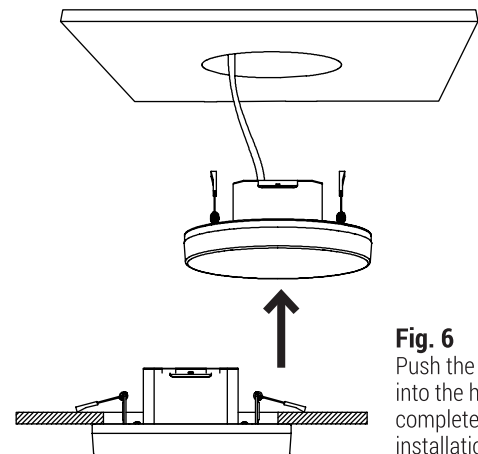
**Fig. 3**  
Install the springs clips (J) as shown with the supplied screws (H).



**Fig. 4**  
Connect the wires in the junction box (black to black, white to white, green to green).



**Fig. 5**  
Toggle the button to adjust the CCT, total 5 CCT can be selected.



**Fig. 6**  
Push the downlight into the hole to complete the installation.