

Catalog Number:	Project Name:	Note:	Date:	Type:
-----------------	---------------	-------	-------	-------

Portor's **Sensor Ready TRO** luminaire, combined with TEELIO's PT-MS-BT sensor, offers seamless integration for a fully smart bluetooth lighting system. Effortlessly control fixtures right from your hand. The Sensor Ready TRO luminaire features wattage and CCT selectability, eliminating the need to stock multiple color temperatures.

Ideal use for office spaces, walkways, schools/campuses, shopping centers, hospitality and health care industry.



CONSTRUCTION

Constructed of one-piece ribbed unitized housing and corners that interlock, preventing damage to luminaire. All sides and corners are turned in and hemmed, removing sharp edges for safe handling and installation.

ELECTRICAL

Luminaire is built with the highest quality 120-277VAC drivers.

OPTICAL SYSTEM

Designed to reduce glare and improve light distribution through precision formed lens optics.

CONTROLS

Sensor ready fixture (consult factory) to maximize energy savings.

LISTING

UL Listed, DLC Premium Listed, RoHS



Scan the QR code to download the TEELIO app and unlock the full experience of being in complete control. Start enjoying seamless, intuitive management at your fingertips.



WATTAGE	DELIVERED LUMENS	EFFICACY
25W	3,511	up to 145 lm/W
30W	4,150	
35W	4,753	

Based on actual IES results @ 4000K setting. Actual lumens may vary.

TECHNICAL SPECIFICATION

CCT	3500K/4000K/5000K
CRI	80
DIMMABLE	0-10V dimmable
BEAM ANGLE	120°
VOLTAGE	120V-277V, 50/60 Hz
MAX. CURRENT (A)	0.29mA
POWER FACTOR	>0.9
THD	≤20%
LIFETIME	L70 > 100,000 hours
WORKING TEMPERATURE	-40°F ~ 122°F
IP RATING	Suitable for damp locations
WARRANTY	5 year limited warranty
DLC PRODUCT ID	XXXXXX



ORDERING SAMPLE: - - - - - - -

Series	Size	CCT/ Wattage	Capability	Accessories/Options (Sold separately)			
				Sensor	EM Battery	Mounting Kit	MC Cable
PT-TRO	14 (1' x 4')	3CP (3500K/4000K/5000K) (25W/30W/35W)	SR (Sensor Ready)	PT-MS-BT	_____ blank PT-EM1-15W	SMK-TRO-14 FK-14	MC-5W-SC-6F MC-6W-SC-6F

Catalog Number:	Project Name:	Note:	Date:	Type:
-----------------	---------------	-------	-------	-------

DIMENSION

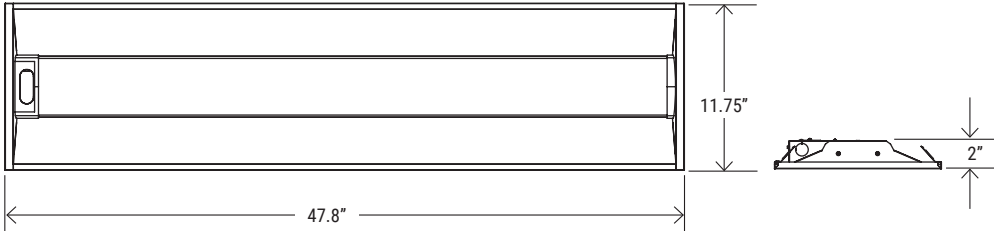

QTY/CARTON

2

PIECE

Net Weight: **6.1 lbs**

Gross Weight: **7.2 lbs**

MOTION SENSOR



PT-MS-BT
Bluetooth
Motion Sensor

EM OPTION



PT-EM1-15W
LED Emergency Driver

MOUNTING KIT



SMK-TRO-14
1'x4' Troffer Surface Mount Kit



FK-14
1'x4' Flange Kit

MC CABLES



MC-5W-SC-6F
MC-6W-SC-6F
MC Cables

PERFORMANCE

WATTAGE	DELIVERED LUMENS	EFFICACY
25W	3,378 @ 3000K	135 lm/W
	3,511 @ 4000K	145 lm/W
	3,475 @ 5000K	138 lm/W
30W	3,973 @ 3000K	131 lm/W
	4,150 @ 4000K	143 lm/W
	4,086 @ 5000K	135 lm/W
35W	4,543 @ 3000K	128 lm/W
	4,753 @ 4000K	140 lm/W
	4,654 @ 5000K	131 lm/W

WATTAGE AND CCT SELECTOR

DEFAULT SETTING: **35W @ 5000K**

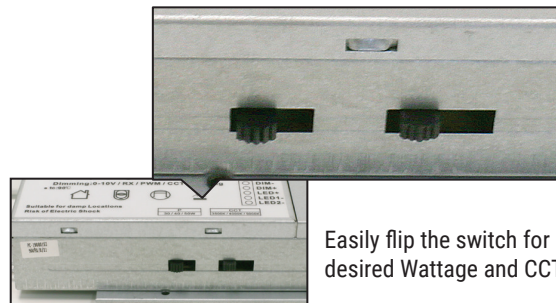

Easily flip the switch for desired Wattage and CCT.



Catalog Number:	Project Name:	Note:	Date:	Type:
-----------------	---------------	-------	-------	-------

Portor's **Sensor Ready TRO** luminaire, combined with TEELIO's PT-MS-BT sensor, offers seamless integration for a fully smart bluetooth lighting system. Effortlessly control fixtures right from your hand. The Sensor Ready TRO luminaire features wattage and CCT selectability, eliminating the need to stock multiple color temperatures.

Ideal use for office spaces, walkways, schools/campuses, shopping centers, hospitality and health care industry.



CONSTRUCTION

Constructed of one-piece ribbed unitized housing and corners that interlock, preventing damage to luminaire. All sides and corners are turned in and hemmed, removing sharp edges for safe handling and installation.

ELECTRICAL

Luminaire is built with the highest quality 120-277VAC drivers.

OPTICAL SYSTEM

Designed to reduce glare and improve light distribution through precision formed lens optics.

CONTROLS

Sensor ready fixture (consult factory) to maximize energy savings.

LISTING

UL Listed, DLC Premium Listed, RoHS



Scan the QR code to download the TEELIO app and unlock the full experience of being in complete control. Start enjoying seamless, intuitive management at your fingertips.



WATTAGE	DELIVERED LUMENS	EFFICACY
25W	3,511	up to 145 lm/W
30W	4,150	
35W	4,753	

Based on actual IES results @ 4000K setting. Actual lumens may vary.

TECHNICAL SPECIFICATION

CCT	3500K/4000K/5000K
CRI	80
DIMMABLE	0-10V dimmable
BEAM ANGLE	120°
VOLTAGE	120V-277V, 50/60 Hz
MAX. CURRENT (A)	0.29mA
POWER FACTOR	>0.9
THD	≤20%
LIFETIME	L70 > 100,000 hours
WORKING TEMPERATURE	-40°F ~ 122°F
IP RATING	Suitable for damp locations
WARRANTY	5 year limited warranty
DLC PRODUCT ID	XXXXXX



ORDERING SAMPLE: - - - - - - -

Series	Size	CCT/ Wattage	Capability	Accessories/Options (Sold separately)			
				Sensor	EM Battery	Mounting Kit	MC Cable
PT-TRO	22 (2' x 2')	3CP (3500K/4000K/5000K) (25W/30W/35W)	SR (Sensor Ready)	PT-MS-BT	_____ blank PT-EM1-15W	SMK-TRO-22 FK-22	MC-5W-SC-6F MC-6W-SC-6F

Catalog Number:	Project Name:	Note:	Date:	Type:
-----------------	---------------	-------	-------	-------

DIMENSION

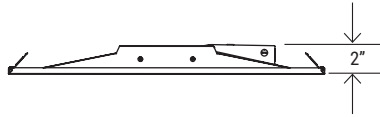
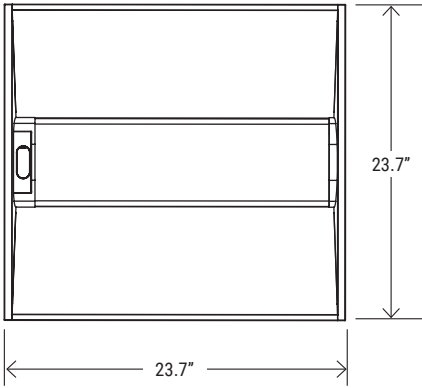

QTY/CARTON



PIECE

Net Weight: **5.1 lbs**

Gross Weight: **6.4 lbs**

MOTION SENSOR



PT-MS-BT
Bluetooth
Motion Sensor

EM OPTION



PT-EM1-15W
LED Emergency Driver

MOUNTING KIT

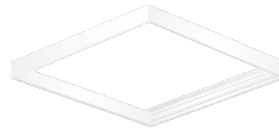

SMK-TRO-22
2'x2' Troffer Surface Mount Kit

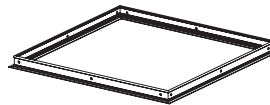

FK-22
2'x2' Flange Kit

MC CABLES



MC-5W-SC-6F
MC-6W-SC-6F
MC Cables

PERFORMANCE

WATTAGE	DELIVERED LUMENS	EFFICACY
25W	3,378 @ 3000K	135 lm/W
	3,511 @ 4000K	145 lm/W
	3,475 @ 5000K	138 lm/W
30W	3,973 @ 3000K	131 lm/W
	4,150 @ 4000K	143 lm/W
	4,086 @ 5000K	135 lm/W
35W	4,543 @ 3000K	128 lm/W
	4,753 @ 4000K	140 lm/W
	4,654 @ 5000K	131 lm/W

WATTAGE AND CCT SELECTOR

DEFAULT SETTING: **35W @ 5000K**

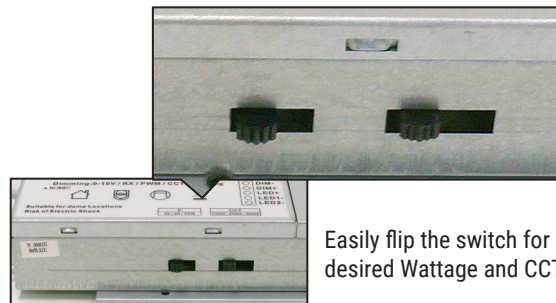

Catalog Number:	Project Name:	Note:	Date:	Type:
-----------------	---------------	-------	-------	-------

Portor's **Sensor Ready TRO** luminaire, combined with TEELIO's PT-MS-BT sensor, offers seamless integration for a fully smart bluetooth lighting system. Effortlessly control fixtures right from your hand. The Sensor Ready TRO luminaire features wattage and CCT selectability, eliminating the need to stock multiple color temperatures.

Ideal use for office spaces, walkways, schools/campuses, shopping centers, hospitality and health care industry.



CONSTRUCTION

Constructed of one-piece ribbed unitized housing and corners that interlock, preventing damage to luminaire. All sides and corners are turned in and hemmed, removing sharp edges for safe handling and installation.

ELECTRICAL

Luminaire is built with the highest quality 120-277VAC drivers.

OPTICAL SYSTEM

Designed to reduce glare and improve light distribution through precision formed lens optics.

CONTROLS

Sensor ready fixture (consult factory) to maximize energy savings.

LISTING

UL Listed, DLC Premium Listed, RoHS



Scan the QR code to download the TEELIO app and unlock the full experience of being in complete control. Start enjoying seamless, intuitive management at your fingertips.



WATTAGE	DELIVERED LUMENS	EFFICACY
34W	4,832	up to 148 lm/W
38W	5,348	
45W	6,199	

Based on actual IES results @ 4000K setting. Actual lumens may vary.

TECHNICAL SPECIFICATION

CCT	3500K/4000K/5000K
CRI	80
DIMMABLE	0-10V dimmable
BEAM ANGLE	120°
VOLTAGE	120V-277V, 50/60 Hz
MAX. CURRENT (A)	0.38mA
POWER FACTOR	>0.9
THD	≤20%
LIFETIME	L70 > 100,000 hours
WORKING TEMPERATURE	-40°F ~ 122°F
IP RATING	Suitable for damp locations
WARRANTY	5 year limited warranty
DLC PRODUCT ID	XXXXXX



ORDERING SAMPLE: - - - - - - -

Series	Size	CCT/ Wattage	Capability	Accessories/Options (Sold separately)			
				Sensor	EM Battery	Mounting Kit	MC Cable
PT-TRO	24 (2' x 4')	3CP (3500K/4000K/5000K) (34W/38W/45W)	SR (Sensor Ready)	PT-MS-BT	_____ blank PT-EM1-15W	SMK-TRO-24 FK-24	MC-5W-SC-6F MC-6W-SC-6F

Catalog Number:	Project Name:	Note:	Date:	Type:
-----------------	---------------	-------	-------	-------

DIMENSION

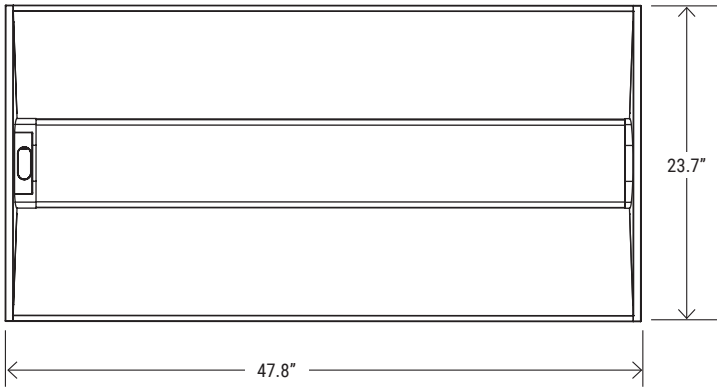

QTY/CARTON



Net Weight: **8.2 lbs**
Gross Weight: **10.3 lbs**

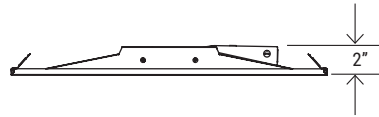

MOTION SENSOR

EM OPTION

MOUNTING KIT

MC CABLES



PT-MS-BT
Bluetooth
Motion Sensor



PT-EM1-15W
LED Emergency Driver



SMK-TRO-24
2'x4' Troffer Surface Mount Kit



FK-24
2'x4' Flange Kit



MC-5W-SC-6F
MC-6W-SC-6F
MC Cables

PERFORMANCE

WATTAGE	DELIVERED LUMENS	EFFICACY
34W	4,651 @ 3000K	138 lm/W
	4,832 @ 4000K	148 lm/W
	4,760 @ 5000K	141 lm/W
38W	5,151 @ 3000K	136 lm/W
	5,348 @ 4000K	146 lm/W
	5,258 @ 5000K	138 lm/W
45W	5,965 @ 3000K	132 lm/W
	6,199 @ 4000K	143 lm/W
	6,054 @ 5000K	135 lm/W

WATTAGE AND CCT SELECTOR

DEFAULT SETTING: **45W @ 5000K**

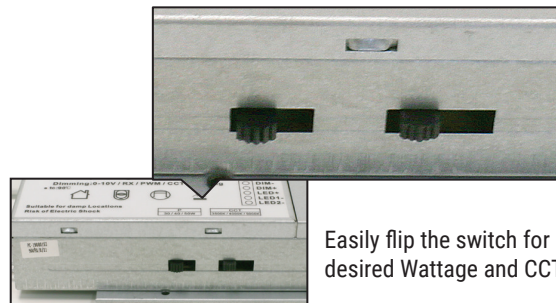

Easily flip the switch for desired Wattage and CCT.

