

Catalog Number:	Project Name:	Note:	Date:	Type:
-----------------	---------------	-------	-------	-------

**DESCRIPTION**

Portor's second generation commercial grade recessed downlight is wattage and color tunable, which can be programmed with a CCT of 2700K, 3000K, 3500K, 4000K, or 5000K, eliminating the need to stock multiple color temperatures.

Ideal use for commercial complexes, hospitality, healthcare industry, schools, shopping centers, industrial areas and hotels.



LED RETROFIT  
**COMMERCIAL**  
GRADE DOWNLIGHT

TUNABLE  
**5CCT**  
SELECTABLE

WATTAGE  
**3W**  
ELECTOR

**Baffle Finish**

**Direct Mounting**

**NO RECESSED HOUSING NEEDED**

FOR RETROFIT OR NEW CONSTRUCTION INSTALLATION



**20" WHIP INCLUDED**

**CONSTRUCTION**

PC driver housing and aluminum baffle with architectural white finish. Standard gasket included to ensure proper seal.

**ELECTRICAL**

Luminaire is built with the highest quality LED drivers, ensuring energy efficiency. Optional emergency battery pack.

**ENERGY SAVINGS**

80% more energy savings than traditional lamps. Low heat production requires less air-conditioning requirements, further increasing energy cost savings.

**INSTALLATION**

The adjustable housing clips allow for installation in a large range of commercial and architectural housings ranging from 6.0"-7.4" (153-190mm). These spring-action clips push up easily and fit securely for both retrofit and new construction installations.

**LISTING**

ETL Listed, FCC, RoHS, CE & Energy Star Listed

NOMINAL WATTAGE	DELIVERED LUMENS	EFFICACY
22W	2005 LM	up to 90 lm/W
30W	2583 LM	
38W	3199 LM	

*Based on 4000K setting. Actual lumens may vary.*

**TECHNICAL SPECIFICATION**

WATTAGE	22W/30W/38W
CCT	<b>2700K   3000K   3500K   4000K   5000K</b>
CRI	90
DIMMABLE	*0-10V, 5-100% smooth dimming
BEAM ANGLE	100°
VOLTAGE	120V-277V
POWER FREQUENCY	50/60 Hz
POWER FACTOR	>0.9
LIFESPAN	50,000 hrs @ L70 lifetime
RATING	Suitable for wet locations
WARRANTY	3 year limited

*\*Must use 0-10v dimming wire. Not compatible for line voltage dimming.*



**ORDERING SAMPLE: PT-CDL2-10I-5C3P**

Series	Aperture	CCT (Selectable)	Wattage (Selectable)	Finished	*Accessories/Options								
<b>PT-CDL2</b> Commercial Grade Downlight	<b>10I</b> (10")	<b>5C</b> (2700K / 3000K / 3500K / 4000K / 5000K)	<b>3P</b> (22W / 30W / 38W)	<b>White</b> (Standard)	<table border="1"> <tr> <td>EM Battery</td> <td>TRIM RING</td> </tr> <tr> <td>Blank (no option)</td> <td>TRR-CDL-10I-BK</td> </tr> <tr> <td>PT-EMG-8W</td> <td>TRR-CDL-10I-BN</td> </tr> <tr> <td>PT-EMG-15W</td> <td>TRR-CDL-10I-BZ</td> </tr> </table>	EM Battery	TRIM RING	Blank (no option)	TRR-CDL-10I-BK	PT-EMG-8W	TRR-CDL-10I-BN	PT-EMG-15W	TRR-CDL-10I-BZ
EM Battery	TRIM RING												
Blank (no option)	TRR-CDL-10I-BK												
PT-EMG-8W	TRR-CDL-10I-BN												
PT-EMG-15W	TRR-CDL-10I-BZ												

Catalog Number:	Project Name:	Note:	Date:	Type:
-----------------	---------------	-------	-------	-------

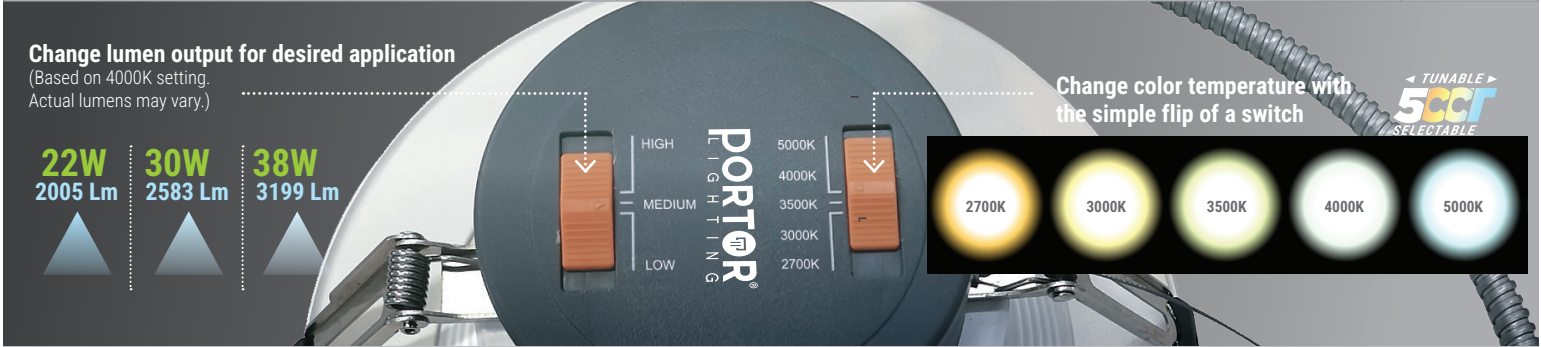

**DIMENSION**

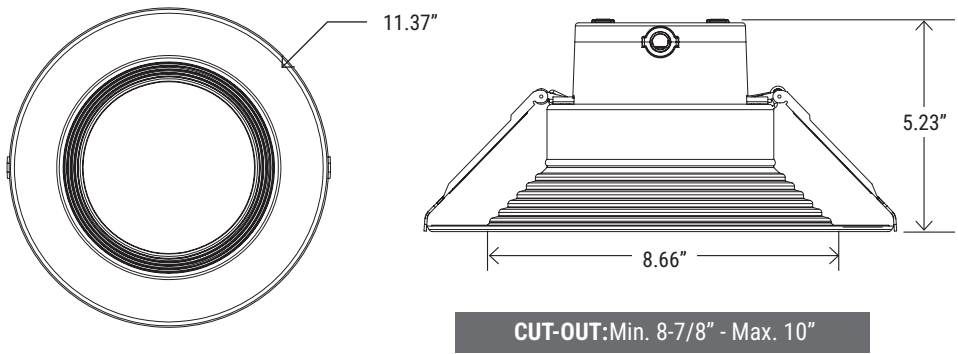

**\*EM BATTERY OPTION (SOLD SEPARATE)**

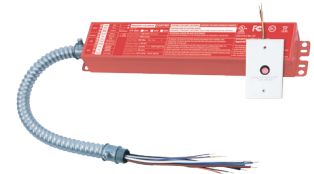

PT-EMG-8W  
PT-EMG-15W  
LED Emergency Driver

**SMOOTH TRIM RING REPLACEMENT (SOLD SEPARATELY)**



**TRR-CDL-10I-BK**  
10" Black Smooth Trim Ring Replacement



**TRR-CDL-10I-BN**  
10" Brush Nickel Smooth Trim Ring Replacement

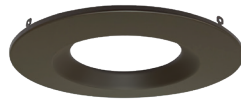

**TRR-CDL-10I-BZ**  
10" Bronze Smooth Trim Ring Replacement

QTY/CARTON

**4**

PIECES

**PHOTOMETRY (Luminous Intensity Distribution Diagram)**

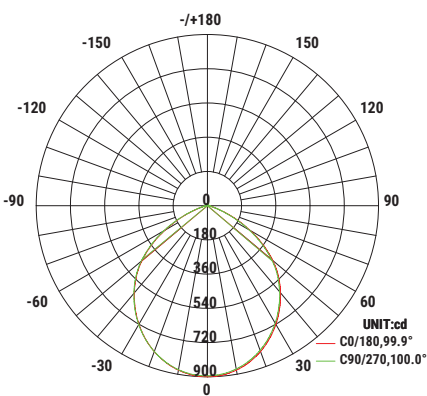

AVERAGE BEAM ANGLE(50%):99.9 DEG

**22W @ 4000K**

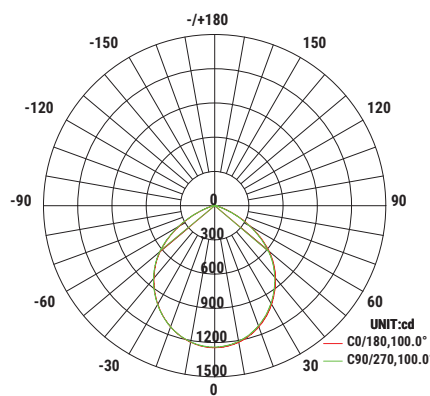

AVERAGE BEAM ANGLE(50%):100.0 DEG

**30W @ 4000K**

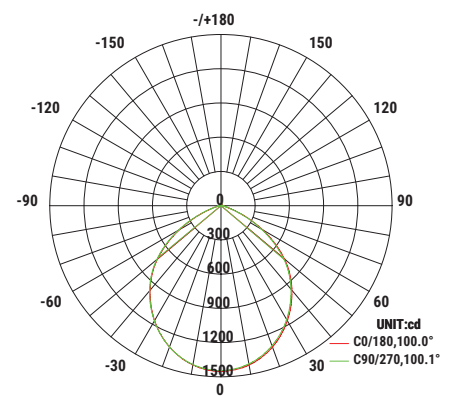

AVERAGE BEAM ANGLE(50%):100.0 DEG

**38W @ 4000K**